



SEGA Bass Fishing Challenge

Universal Kit Kit Installation Instructions & Service Manual

IMPORTANT

- Before using this product, read this manual carefully to understand the contents herein stated.
- After reading this manual, be sure to keep it near the product or in a convenient place for easy reference when necessary.

BEFORE USING THE PRODUCT, BE SURE TO READ THE FOLLOWING:

To maintain safety:

To ensure the safe operation of this product, be sure to read the following before usage. The following instructions are intended for the users, operators and the personnel in charge of the operation of the product. After carefully reading and sufficiently understanding the warning displays and cautions, handle the product appropriately. Be sure to keep this manual close to the product or in a convenient place for future reference.

Herein, explanations which require special attention are enclosed with dual lines. Depending on the potentially hazardous degrees, the terms of DANGER, WARNING, CAUTION, etc. are used. Be sure to understand the contents of the displays before reading the text.



Indicates that mishandling the product by disregarding this pictograph will cause severe injury or death.



Indicates that mishandling the product by disregarding this caution will cause a slight hazardous situation which can result in personal injury and/or material damage.



Indicates that mishandling the product by disregarding this warning will cause a potentially hazardous situation which can result in death or serious injury.

For the safe usage of the product, the following pictographs are used:



Indicates "HANDLE WITH CARE." In order to protect the human body and equipment, this display is attached to places where the Owner's Manual, Serviceman Manual and/or Service Manual should be referred to.



Indicates a "Protective Earth Terminal." Before operating the equipment, be sure to connect it to the Ground.
(The step may be omitted for products in which a power cord with earth is used.)

- **Perform work in accordance with the instructions herein stated.**
Instructions for work are explained by paying attention to the aspect of accident prevention. Failing to perform work as per the instructions can cause accidents. In the case where only those who have technical expertise should perform the work to avoid hazardous situation, the instructions herein state that the site maintenance personnel should perform such work.
- **Be sure to turn off the power before working on the machine.**
To prevent an electric shock, be sure to turn off the power before carrying out any work that requires direct contact with the interior of the product. If the work is to be performed in the power-on status, the Instruction Manual herein always states to that effect.
- **Be sure to ground the Earth Terminal.**
(This is not required in the case where a power cord with earth is used.)
This product is equipped with the Earth Terminal. When installing the product, connect the Earth Terminal to the "accurately grounded indoor earth terminal" by using an earth wire. Unless the product is grounded appropriately, the user can be subject to an electric shock. After performing repair, etc. for the control equipment, ensure that the Earth Wire is firmly connected to the control equipment.
- **Ensure that the Power Supply used is equipped with an Earth Leakage Breaker.**
This product does not incorporate the Earth Leakage Breaker. Using a power supply which is not equipped with the Earth Leakage Breaker can cause a fire when earth leakage occurs.
- **Be sure to use fuses which meet the specified rating.**
(Only for the machines which use fuses.)
Using fuses exceeding the specified rating can cause a fire and an electric shock.

- **Specification changes (removal of equipment, conversion and addition) not designated by SEGA are not allowed.**

The parts of the product include warning labels for safety, covers for personal protection, etc. It is very hazardous to operate the product by removing parts and/or modifying the circuits. Should doors, lids and protective parts be damaged or lost, refrain from operating the product, and contact where the product was purchased from or the office herein stated.

SEGA shall not be held responsible for any accidents, compensation for damage to a third party, resulting from the specifications not designated by SEGA.

- **Ensure that the product meets the requirements of appropriate Electrical Specifications.**

Before installing the product, check for Electrical Specifications. SEGA products have a nameplate on which Electrical Specifications are described. Ensure that the product is compatible with the power supply voltage and frequency requirements of the location. Using any Electrical Specifications different from the designated Specifications can cause a fire and an electric shock.

- **Install and operate the product in places where appropriate lighting is available, allowing warning labels to be clearly read.**

To ensure safety for the customers, labels and printed instructions describing potentially hazardous situations are applied to places where accidents can be caused. Ensure that where the product is operated has sufficient lighting allowing the warnings to be read. If any label is peeled off, apply it again immediately. Please place an order with where the product was purchased from or the office herein stated.

- **When handling the monitor, be very careful. (Applies only to the product with a monitor.)**

Some of the monitor (TV) parts are subject to high tension voltage. Even after turning off the power, some portions are still subject to high tension voltage sometimes. Monitor repair and replacement should be performed only by those technical personnel who have knowledge of electricity and technical expertise.

- **Be sure to adjust the monitor/projector properly. (Applies only to the product with a monitor/projector.)**

Do not operate the product leaving on-screen flickering or blurring as it is. Using the product with the monitor/projector not properly adjusted may cause dizziness or a headache to an operator, a player, or the customers.

- **When transporting or reselling this product, be sure to attach this manual to the product.**

In the case where commercially available monitors and printers are used in this product, only the contents relating to this product are explained herein. Some commercially available equipment has functions and reactions not stated in this manual. Read this manual together with the specific Instruction Manual of such equipment.

**Descriptions herein contained may be subject to improvement changes without notice.*

**The contents described herein are fully prepared with due care. However, should any question arise or errors be found, please contact SEGA.*

INSPECTIONS IMMEDIATELY AFTER TRANSPORTING THE PRODUCT TO THE LOCATION

Normally, at the time of shipment, SEGA products are in a status allowing for usage immediately after transporting to the location. Nevertheless, an irregular situation may occur during transportation. Before turning on the power, check the following points to ensure that the product has been transported in a satisfactory status.

- Are there any dented portions or defects (cuts, etc.) on the external surfaces of the cabinet?
- Are Casters and Adjusters damaged?
- Do the power supply voltage and frequency requirements meet with those of the location?
- Are all wiring connectors correctly and securely connected? Unless connected in the correct way, connector connections can not be made accurately. Do not insert connectors forcibly.
- Do power cords have cuts and dents?
- Do the fuses used meet specified ratings? Is the Circuit Protector in an energized status?
- Are all accessories available?
- Can all Doors and Lids be opened with the Accessory Keys? Can Doors and Lids be firmly closed?

TABLE OF CONTENTS

BEFORE USING THE PRODUCT, BE SURE TO READ THE FOLLOWING:

TABLE OF CONTENTS	i
INTRODUCTION	iii
1 HANDLING PRECAUTIONS	1
2 PRECAUTIONS REGARDING INSTALLATION LOCATION	2
2-1 LIMITATIONS OF USAGE	2
3 PRECAUTIONS REGARDING PRODUCT OPERATION	3
4 PART DESCRIPTIONS	5
5 ACCESSORIES	7
6 ASSEMBLY AND INSTALLATION	8
6-1 INSTALLATION	9
6-2 TURNING ON THE POWER (SOFTWARE INSTALLATION)	10
6-3 CHECKING ASSEMBLY (SETUP)	10
7 PRECAUTIONS WHEN MOVING THE MACHINE	13
8 GAME DESCRIPTION	14
8-1 GAME OUT LINE	14
8-2 HOW TO CONTROL	15
8-3 HOT TO FISH	17
8-4 BONUS GAME	18
8-5 SPECIAL LURE	19
8-6 GAME FLOW	20

9 SYSTEM MENU 22

 9-1 SWITCH UNIT AND COIN METER23

 9-2 SYSEM MENU24

 9-3 TEST MODE25

 9-4 CONFIGULRATION27

 9-5 BOOKKEEPING29

 9-6 BACKUP CLEAR31

10 TOURNAMENT 33

 10-1 TOURNAMENT.....33

 10-2 START DAY, END DAY36

 10-3 SELECT MARCHANDISE37

 10-4 ADVERTIZE SCREEN EDITOR38

 10-5 PRITABLE TEXT EDITOR.....39

 10-6 PLAY LOG39

 10-7 ABOUT PRINTER.....40

11 PERIODIC INSPECTION 45

12 TROUBLESHOOTING 46

 12-1 TROUBLESHOOTING (WHEN NO ERROR MESSAGE IS SHOWN).....46

 12-2 ERROR CODE.....46

13 GAME BOARD 47

14 CABINET PARTS DESCRIPTION 51

15 PARTS LIST, CONTROLLER 52

16 WIRE COLOR CODE TABLE 53

17 WIRING DIAGRAM..... 54

18 LINCENSE MARK..... 56

19 PRINTER KIT (OPTION)..... 57

INTRODUCTION

This manual is intended to provide detailed descriptions together with all the necessary information covering the general operation of electronic assemblies, electro-mechanicals, servicing control, spare parts, etc. for the product, **“SEGA BASS FISHING CHALLENGE, CVT KIT”**.

This manual is intended for the owners, personnel and managers in charge of operation of the product.

Operate the product after carefully reading and sufficiently understanding the instructions.

In the unlikely event that the product does not function correctly, **DO NOT** allow anyone other than a technician to touch the internal system. Turn off the power to the machine, making sure to unplug the electrical cord from the outlet, and contact the office listed below or the point of purchase for this product.

Use of this product is unlikely to cause physical injuries or damage to property. However, points that require special attention are indicated by bold text, the word **“IMPORTANT”** and the symbol below.



Indicates important information that, if ignored, may result in the mishandling of the product and cause faulty operation or damage to the product.

Sega Amusements U.S.A., Inc.

800 Arthur Avenue, Elk Grove Village, IL 60007-5215, U.S.A.

TEL: 1-847-364-9787

TOLL FREE: 1-888-877-2669

FAX: 1-847-427-1065

Definition of 'Site Maintenance Personnel or Other Qualified Individuals'

⚠️ WARNING

Procedures not described in this manual or marked as 'to be carried out by site maintenance personnel or other qualified professionals' should not be carried out by personnel without the necessary skill or technology. Work carried out by unqualified persons may cause serious accidents, including electrocution.

Parts replacement, maintenance inspections and troubleshooting should be carried out by site maintenance personnel or other qualified professionals. This manual includes directions for potentially dangerous procedures which should only be carried out by professionals with the appropriate specialized knowledge.

The site maintenance personnel or other qualified professionals mentioned in this manual are defined as follows:

Site maintenance personnel:

Individuals with experience in maintaining amusement equipment, vending machines, etc., working under the supervision of the owner/operator of this product to maintain machines within amusement facilities or similar premises by carrying out everyday procedures such as assembly, maintenance inspections, and replacement of units/expendable parts.

Activities to be carried out by site maintenance personnel:

Amusement equipment/vending machine assembly, maintenance inspection and replacement of units/expendable parts.

Other qualified professionals:

Persons employed by amusement equipment manufacturers, or involved in design, production, testing or maintenance of amusement equipment. The individual should have either graduated from technical school or hold similar qualifications in electrical/electronics/mechanical engineering.

Activities to be carried out by other qualified professionals:

Amusement equipment/vending machine assembly, repair/adjustment of electrical/electronic/mechanical parts.

1 HANDLING PRECAUTIONS

When installing or inspecting the machine, be very careful of the following points and pay attention to ensure that the player can enjoy the game safely.

Non-compliance with the following points or inappropriate handling running counter to the cautionary matters herein stated can cause personal injury or damage to the machine.

⚠ WARNING

- Before performing work, be sure to turn the power off. Performing the work without turning the power off can cause an electric shock or short circuit. In the case work should be performed in the status of power on, this manual always states to that effect.
- To avoid an electric shock or short circuit, do not plug in or unplug quickly.
- To avoid an electric shock, do not plug in or unplug with a wet hand.
- Do not expose power cords or earth wires on the surface, (floor, passage, etc.). If exposed, the power cords and earth wires are susceptible to damage. Damaged cords and wires can cause an electric shock or short circuit.
- To avoid causing a fire or an electric shock, do not put things on or damage the power cords.
- When or after installing the product, do not unnecessarily pull the power cord. If damaged, the power cord can cause a fire or an electric shock.
- In case the power cord is damaged, ask for a replacement through where the product was purchased from or the office herein stated. Using the cord as is damaged can cause fire, an electric shock or leakage.
- Be sure to perform grounding appropriately. Inappropriate grounding can cause an electric shock.
- Be sure to use fuses meeting the specified rating. Using fuses other than the specified rating can cause a fire or an electric shock.
- Be sure that connections such as IC BD are made properly. Insufficient insertion can cause an electric shock.
- Specification changes, removal of equipment, conversion and/or addition, not designated by SEGA are not permitted.
 - Failure to observe this may cause a fire or an electric shock. Non-compliance with this instruction can have a bad influence upon physical conditions of the players or the onlookers, or result in injury during play.
 - SEGA shall not be held responsible for damage, compensation for damage to a third party, caused by specification changes not designated by SEGA.
- Do not perform any work or change parts not listed in this manual. Doing so may lead to an accident.
If you need to perform any work not listed in this manual, request work from the office indicated in this manual or the point of purchase, or inquires for details.
- Be sure to perform periodic maintenance inspections herein stated.

STOP IMPORTANT

- For the IC board circuit inspections, only the logic tester is allowed. The use of a multiple-purpose tester is not permitted, so be careful in this regard.
- When cleaning the CRT surfaces, use a soft and dry cloth. Do not apply chemicals such as thinner, benzene, etc.
- Static electricity from your body may damage some electronics devices on the IC board. Before handling the IC board, touch a grounded metallic surface so that the static electricity can be discharged.
- Some parts are not designed and manufactured specifically for this game machine. The manufacturers may discontinue, or change the specifications of such general-purpose parts. If this is the case, SEGA cannot repair or replace a failed game machine whether or not a warranty period has expired.

2 PRECAUTIONS REGARDING INSTALLATION LOCATION

WARNING

This product is an indoor game machine. Do not install it outside. Even indoors, avoid installing in places mentioned below so as not to cause a fire, electric shock, injury and/or malfunction.

- Places subject to rain or water leakage, or places subject to high humidity in the proximity of an indoor swimming pool and/or shower, etc.
- Places subject to direct sunlight, or places subject to high temperatures in the proximity of heating units, etc.
- Places filled with inflammable gas or vicinity of highly inflammable/volatile chemicals or hazardous matter.
- Dusty places.
- Sloped surfaces.
- Places subject to any type of violent impact.
- Vicinity of anti-disaster facilities such as fire exits and fire extinguishers.
- Areas where the temperature exceeds the applicable temperature (ambient temperature) range of 5 to 30 degrees centigrade.

2-1 LIMITATIONS OF USAGE

WARNING

- Be sure to check the Electrical Specifications. Ensure that this product is compatible with the location's power supply, voltage, and frequency requirements. A plate describing Electrical Specifications is attached to the product. Non-compliance with the Electrical Specifications can cause a fire and electric shock.
- This product requires a breaker and earth mechanism as part of the location facilities. Using the product without these can cause a fire and electric shock.
- Ensure that the indoor wiring for the power supply is rated at 15 A or higher (AC single phase 100 V ~ 120 V area). Non-compliance with the Electrical Specifications can cause a fire and electric shock.
- Be sure to use an independent power supply equipped with an earth leakage breaker. Using a power supply without an earth leakage breaker can cause an outbreak of fire if a power surge occurs.
- Putting many loads on one electrical outlet can cause generation of heat and a fire resulting from overload.
- When using an extension cord, ensure that the cord is rated at 15 A or higher (AC 100 V ~ 120 V area). Using a cord rated lower than the specified rating can cause a fire and electric shock.

3 PRECAUTIONS REGARDING PRODUCT OPERATION

To avoid injury and trouble, be sure to pay attention to the behavior of visitors and players.

BEFORE OPERATION

⚠ WARNING

In order to avoid accidents, check the following before starting the operation:

- To ensure maximum safety for the players and the customers, ensure that where the product is operated has sufficient lighting to allow any warnings to be read. Operation under insufficient lighting can cause bodily contact with each other, hitting accident, and/or trouble between customers.
- Be sure to perform appropriate adjustment of the monitor (projector). For operation of this machine, do not leave monitor's flickering or deviation as is. Failure to observe this can have a bad influence upon the players' or the customers' physical conditions.
- It is suggested to ensure a space allowing the players who feel sick while playing the game to take a rest.
- Check if all of the adjusters are in contact with the surface. If they are not, the Cabinet can move and cause an accident.

⚠ WARNING

- Do not put any heavy item on this product. Placing any heavy item on the product can cause a falling down accident or parts damage.
- Do not climb on the product. Climbing on the product can cause falling down accidents. To check the top portion of the product, use a step ladder.
- To avoid electric shock, check to see if door & cover parts are damaged or omitted.
- To avoid electric shock, short circuit and/or parts damage, do not put the following items on or in the periphery of the product. Flower vases, flowerpots, cups, water tanks, cosmetics, and receptacles/containers/vessels containing chemicals and water.

⚠ CAUTION

- During daily cleaning, be sure to check the surface of the steering wheel, gear shifter, and other parts that the player touches with his hands for damage, cracks, or loose screws. If a player uses the machine while it is damaged, cracked, or has a loose screw, the player may become injured.
- During daily cleaning, be sure to check the seat for any abnormality, wetness, etc. Failure to do this may result in deliberate tampering or negligence being left undetected.
- To avoid injury, be sure to provide sufficient space by considering the potentially crowded situation at the installation location. Insufficient installation space can cause making bodily contact with each other, hitting accidents, and/or trouble between customers.

DURING OPERATION (PAYING ATTENTION TO CUSTOMERS)

WARNING

- For safety reasons, do not allow any of the following people to play the game.
 - Those who need assistance such as the use of an apparatus when walking.
 - Those who have high blood pressure or a heart problem.
 - Those who have experienced muscle convulsion or loss of consciousness when playing video games, etc.
 - Those who have neck or spinal cord problems.
 - Those who are intoxicated or under the influence of drugs.
 - Pregnant women.
 - Persons susceptible to motion sickness.
 - Persons who disregard the product's warning displays.
- Even players who have never been adversely affected by light stimulus might experience dizziness or headache depending on their physical condition when playing the game. Small children are especially likely to experience these symptoms. Caution guardians of small children to keep watch on their children during play.
- Instruct those who feel sick during play to have a medical examination.
- To avoid injury from falls and electric shocks due to spilled drinks, instruct the player not to place heavy items or drinks on the product.
- To avoid electric shocks and short circuits, do not allow customers to put hands and fingers or extraneous matter in the openings of the product or small openings in or around the doors.
- To avoid falls and resulting injury, immediately stop the customer from leaning against or climbing on the product, etc.
- To avoid electric shock and short circuit, do not allow customers to unplug the power plug without a justifiable reason.

CAUTION

Immediately stop such violent acts as hitting and kicking the product. Such violent acts can cause parts damage or falling down, resulting in injury due to fragments and falling down.

4 PART DESCRIPTIONS

SEGA BASS FISHING CHALLENGE, FULL KIT

KIT Part#: 557-00-003

Main PCB, AW
Part#: 99-10-011

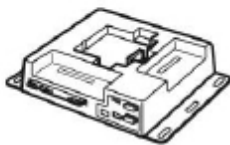

Marquee BASS FISHING
Part#: 557-30-100



EX I/O Cartridge
Part#: 99-20-005



ASSY ROM CTRG SBFC
Part#: 610-0752P ,+ 557-30-200



SEGA LOGO FOR GOLF CABI
Part#: 557-30-102



TRACKBALL 3" HIGH LIP
Part#: 99-50-205



TRACKBALL MOUNT PLATE
Part#: 99-50-206



COVER CARD READER
Part# 523-50-125

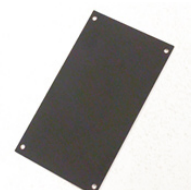

HARNESS FOR IT PWR SPLY
Part#: 557-60-100



HARNESS FOR TRACKBALL
Part#: 557-60-101



HARNESS FOR MAIN A/W
Part#: 99-60-690



CNTL PNL BASS FISHING
Part#: 557-30-151



Manual, SBFC
Part#: 557-30-300



BUTOTNS (5 pcs)
Part#: 99-50-000 WHITE x 2
Part# 99-50-001 RED x 1
Part# 99-50-004 GREEN x 2



SEGA BASS FISHING CHALLENGE, UPDATE KIT

KIT Part#: 557-00-067

ASSY ROM CTRG SBFC
Part#: 610-0752P ,+ 557-30-200



TRACKBALL 3" HIGH LIP
Part#: 99-50-205



HARNESS FOR IT PWR SPLY
Part#: 557-60-100



CNTL PNL BASS FISHING
Part#: 557-30-151



Marquee BASS FISHING
Part#: 557-30-100



TRACKBALL MOUNT PLATE
Part#: 99-50-206

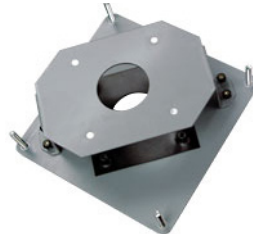

HARNESS FOR TRACKBALL
Part#: 557-60-101



Manual, SBFC
Part#: 557-30-300



COVER CARD READER
Part# 523-50-125

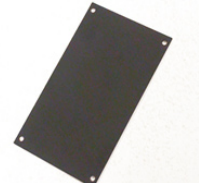

SEGA LOGO FOR GOLF CABI
Part#: 557-30-102



HARNESS FOR MAIN A/W
Part#: 99-60-690



BUTOTNS (5 pcs)
Part#: 99-50-000 WHITE x 2
Part# 99-50-001 RED x 1
Part# 99-50-004 GREEN x 2



SEGA BASS FISHING CHALLENGE, PRINTER KIT

KIT Part#: 557-00-069

PRINTER WITH PAPER HOLDER
Part#: 99-00-919

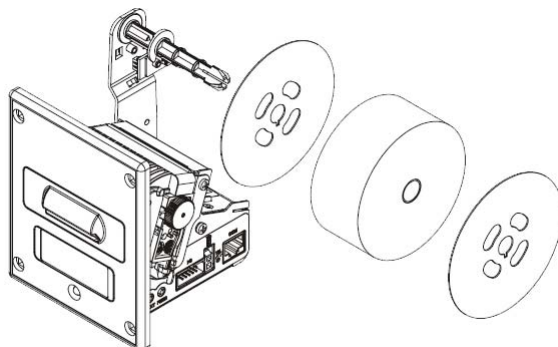

PRINTER SERIAL CABLE
Part#: 99-00-922



5 ACCESSORIES

Confirm that the accessories listed in the table below are present when setting up the product. Accessories marked “Spare” in the note column are consumable items but included as spares.

OWNER'S MANUAL 557-30-300 (1) This manual



Technical Support

Sega Amusements Europe Ltd
Block "C" : 42. Barwell Business Park
Leatherhead Road
Chessington,
Surrey,
KT9 2NY
United Kingdom



Call: +44 (0) 208 391 8072 or +44 (0) 208 391 8094



www.segatotalsolutions.com

6 ASSEMBLY AND INSTALLATION

WARNING

- Perform assembly work by following the procedure herein stated. Failure to comply with the instructions can cause electric shock.
- Perform assembling as per this manual. Since this is a complex machine, incorrect assembling can cause an electric shock, machine damage and/or improper functioning as per specified performance.
- When assembling, more than one person is required. Depending on the assembly work, there are some cases in which working by one person alone can cause personal injury or parts damage.
- Ensure that connectors are properly connected. Improper connections can cause electric shock.
- This work should be carried out by the site maintenance personnel or other qualified professionals. Work performed by non-technical personnel can cause a severe accident such as electric shock. Failing to comply with this instruction can cause a severe accident such as electric shock to the player during operation. If no one with proper technological expertise is available, request service from the office indicated in this document or the point of purchase so as to ensure safety.
- Provide sufficient space so that assembling can be performed. Performing work in places with narrow space or low ceiling may cause an accident and assembly work to be difficult.
- To perform work safely and avoid serious accident such as the cabinet falling down, do not perform work in places where step-like grade differences, a ditch, or slope exist.
- Be careful not to damage the wires. Damaged wires may cause electric shock or short circuit or present a risk of fire.
- Do not leave power cords, ground wires, or network cables exposed in areas of heavy foot traffic. Doing so may cause them to become damaged, possibly resulting in electric shock and/or short circuits. When laying wiring across the floor, always use safety covers to protect the wires.
- The power cord for this product has a ground terminal. Make sure to use this ground terminal when plugging it in to an indoor outlet. Failure to properly ground the product could lead to electrocution. It can also lead to malfunction.

CAUTION

- When opening/closing, attaching/removing doors or lids, be careful that your hand or finger does not get caught in anything.
- To perform the operation safely and accurately you must use a safe, steady footstool or stepladder. Working without this may lead to a fall and possible injury.
- Wear appropriate work clothing so that work can be performed safely. Use gloves and safety shoes to prevent accidents or injuries.
- When installing a wire protection cover over a floor, use a material shaped so that no one passing by will stumble over it. Using a material that could be stumbled over might lead to an accidental fall.
- Handle plastic parts with care. Excessive weight or pressure may cause them to break and the broken pieces may cause injury.

6-1 INSTALLATION

3 kinds as below.

NOTE: This kit available for VGA (31K) and CGA (15K) monitors.

FULL KIT

AW Main PCB included. This KIT will be able to install to Basic CRT monitor UR cabinets with JAMMA connector on Main harness.

Installation:

- 1) Mount TRACKBALL W/MOUTING BRKT(1), BUTTONS (5) and Place New Overlay.
- 2) Place MAIN A/W , TRACKBALL,/POWER HARNESS to your cabinet.
- 2) Place NEW MARQUEE and SEGA LOCO DECALS.
- 3) Remove current GAME BOARDS from cabinet. Place AW MAIN PCB with EX I/O CARTRIDGE and GAME ROM CARTRIDGE.

UPDATE KIT

Your cabinet must have AW MAIN PCB and in the cabinet. .

Installation:

- 1) Mount TRACKBALL W/MOUTING BRKT(1), BUTTONS (5) and Place New Overlay.
- 2) Place MAIN A/W , TRACKBALL,/POWER HARNESS to your cabinet.
- 3) Place NEW MARQUEE and INSTRUCTION.
- 4) Remove current GAME CARTRIDGE from AW MAIN PCB.

PRINTER KIT

Installation: Refer section 19.

Example of cabinet overview



6-2 TURNING ON THE POWER

⚠ WARNING

- The following explanation assumes that the product has been assembled properly as explained above. If there is an error or if the product operates in a manner other than as indicated below, cut off the power supply immediately. Failure to do so may result in a fire or electrical shock.

- 1 Turn the main power switch on to power up.
- 2 The monitor will display an advertize screen.
- 3 The Marquee panel and push buttons will light up. (Depends of cabinet type)
- 4 The sound will be output from both left and right speakers on the cabinet.

6-3 CHECKING ASSEMBLY (SETUP)

Checking Assembly

In the TEST MODE, ensure that the assembly has been made correctly and the connecting board, and input and output device are satisfactory. (Refer to 9-3 “TEST MODE”)

(1) COLOR TEST

In the TEST mode menu, selecting COLOR TEST allows the screen (on which the monitor is tested) to be displayed. Adjust the monitor, if it is necessary.



(2) CROSS HATCH

In the TEST mode menu, selecting CROSS HATCH allows the screen (on which the monitor is sized) to be displayed. Adjust the monitor, if it is necessary.

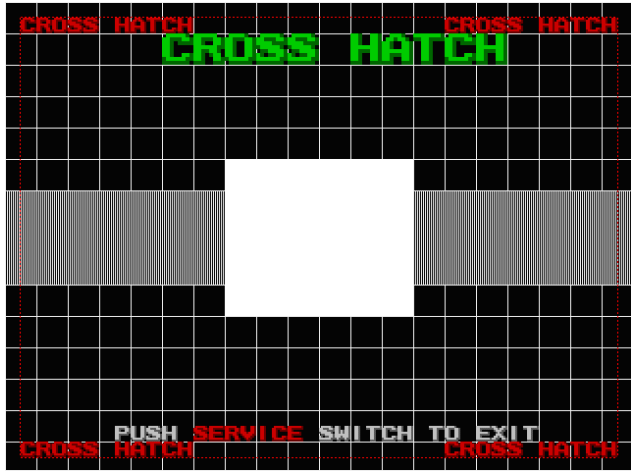

(3) SOUND TEST

In the TEST mode menu, selecting SOUND TEST allows the screen (on which the monitor is tested sound) to be displayed. Make sure that all speakers are outputting correctly.

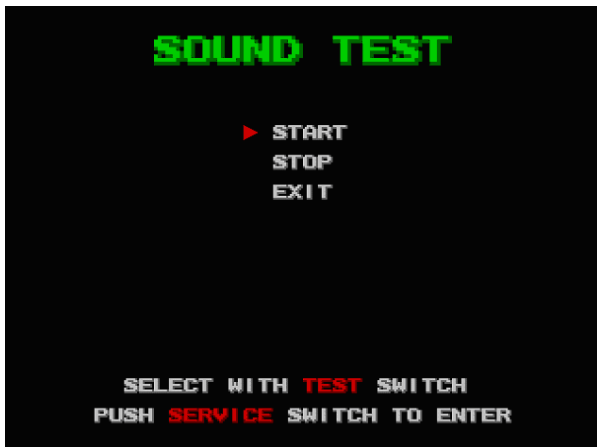

ADJUSTMENT OF SOUND VOLUME

Use dial adjustment volume on Main PCB to adjusting the volume of game.

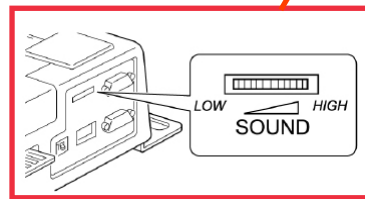
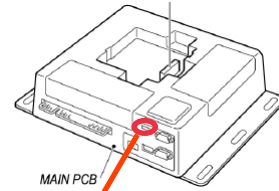

(4) I/O TEST

Press each switch to check that each is working. If the display next to the input device changes to be "ON", switches and connections are working correctly.

An arrow is displayed on this screen when the Trackball spins. Make sure that directions of both Trackball spin and direction of arrow are correct.



(5) CLOCK SETTINGS

Enter in “SYSTEM MENU”, “CONFIGURATION” and “CLOCK SETTING” and enter date correctly. Select CLOCK SETTINGS to display setting date and hour of Main PCB screen. Use the TEST Button to move the cursor and the SERVICE Button to change the set value.

- YEAR: Set a year ; from 2002 to 2038.
- MONTH: Set a month; from 1 to 12.
- DAY: Set a day; from 1 to 31.
- HOUR: Set time; from 0 to 23.
- MINUTE: Set minutes; from 0 to 59.



Move the cursor to “SAVE&EXIT” after setting change is complete. Press SERVICE Button to return to SYSTEM menu after setting is saved.

(6) PRINTER TEST

If connecting a printer, enter in “SYSTEM MENU”, “CONFIGURATION”, “GAME SETTINGS”, ” PRINTER SETTINGS” and ” PRINTER TEST”. Test printing.



The following result is printed form a printer.

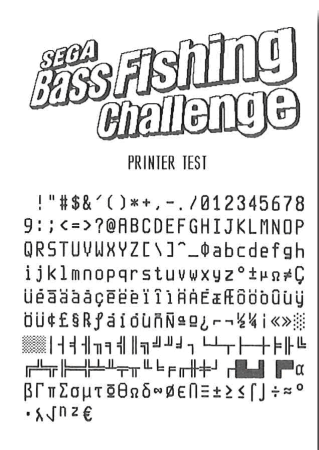

7 PRECAUTIONS WHEN MOVING THE MACHINE

WARNING

- When moving the machine, be sure to pull out the plug from the power supply. Moving the machine with the plug still inserted can cause the power cord to be damaged, resulting in a fire and/or electric shock.
- When moving the machine on the floor, retract the adjusters, and ensure that the casters make contact with the floor. Pay careful attention so that the casters do not run over power cords and earth wires. Damaging the power cords can cause an electric shock and/or short circuit.
- When moving the cabinet, do not push it from the side. Push it from the back. Pushing the cabinet from the side can have the cabinet fall down, causing personal injury, etc. In case the floor has slanted surfaces or step-like differences, be sure to move the machine by 2 or more persons.
- When detached always keep the cabinet on a level surface and make sure it does not start to lean to the left or right whilst working on it.

CAUTION

Do not push on any parts made of glass or plastic, as these parts may break and result in bodily injury.



IMPORTANT

When moving the cabinet do not hold or push the onitor panel. This could deform their shape or cause damage to them.

Pushing the cabinet from the side may make it fall over. Always push it from the back.

8 GAME DESCRIPTION

The following explanations apply to the product when functioning properly. If the product operates differently from the following contents, a fault may have occurred. Immediately look into and eliminate the cause of the fault to ensure proper operation.

Demo movies and game rankings are displayed on a monitor during power distribution.

Audio may also be played from speakers on the video cabinet and gun controller.

It is possible to select whether sound is output or not during Advertise mode through System menu.

8-1 GAME OUT LINE

- Join a tournament in 4 lakes.

A player joins bass fishing tournaments in 4 days. Tournaments are hold in each lake (California Delta, Lake Champlain, Lake Tohopekaliga, Lake Havasu) in all over the US and a player choose a lake.

- Contest gross bass weight in 4 days.

Content gross 5 basses weight per day in a tournament and final ranking is decided by gross bass weight in all 4 days. ("Weigh-in" is hold after finishing each day and tentative ranking is decided. A big weigh-in is hold in special site after finishing 4 days and the victory is decided.).

- Keeping maximum 5 basses per day are possible.

A player can keep maximum 5 basses in a livewell. At the fishing of 6th basses, release the lightest bass in the 6 fishes automatically. The bass which body length is less than 12inch is NON-KEEPER and a player can't count in livewell. It is released automatically.

- Gross weight ranking in each lake.

The player will join weigh in ranking that is contest of gross bass weight in selected lake. After finishing the game, the ranking is reflected the ranking list in advertise screen.

- Bass world-record ranking.

This ranking is to contest only one bass weight in each lake. If one bass weight is heavy, it is possible to enter in the ranking. After finishing the game, the world-record ranking is reflected the ranking list in advertise screen.

- Fish a largemouth bass and smallmouth bass.

A player can fish Largemouth bass and Smallmouth bass in this game.

The kinds of basses caught in each lake are as follow;

Largemouth Bass:	California Delta, Lake Tohopekaliga, Lake Havasu
Smallmouth Bass :	Lake Champlain

- Number of Players.

1-4 players are playable.

- Game Mode

There are 2 modes in this game; "Short Competition" mode is to join a tournament in only one day. "Full Competition" mode is to join a tournament in 4 days. If a player selects "Continue" in Short Competition, a player can join a tournament in all 4 days.

8-2 HOW TO CONTROL

- CONTROL PANEL LAYOUT

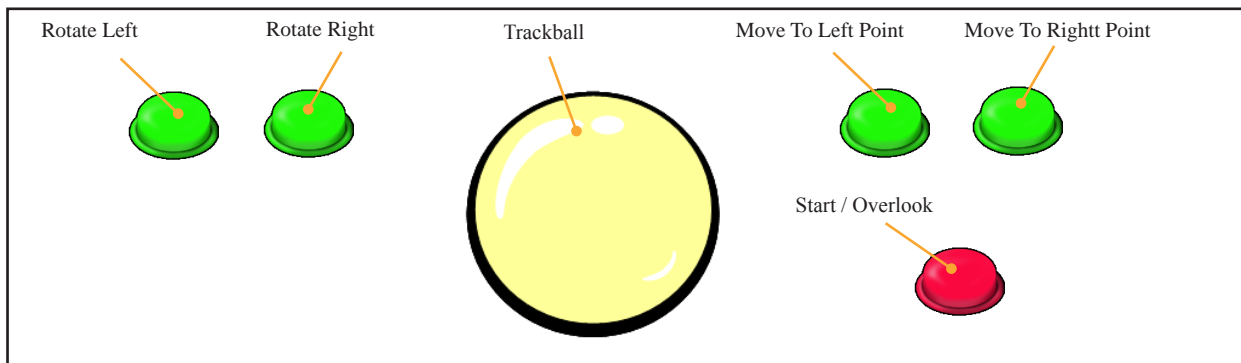

- MAIN SCREEN

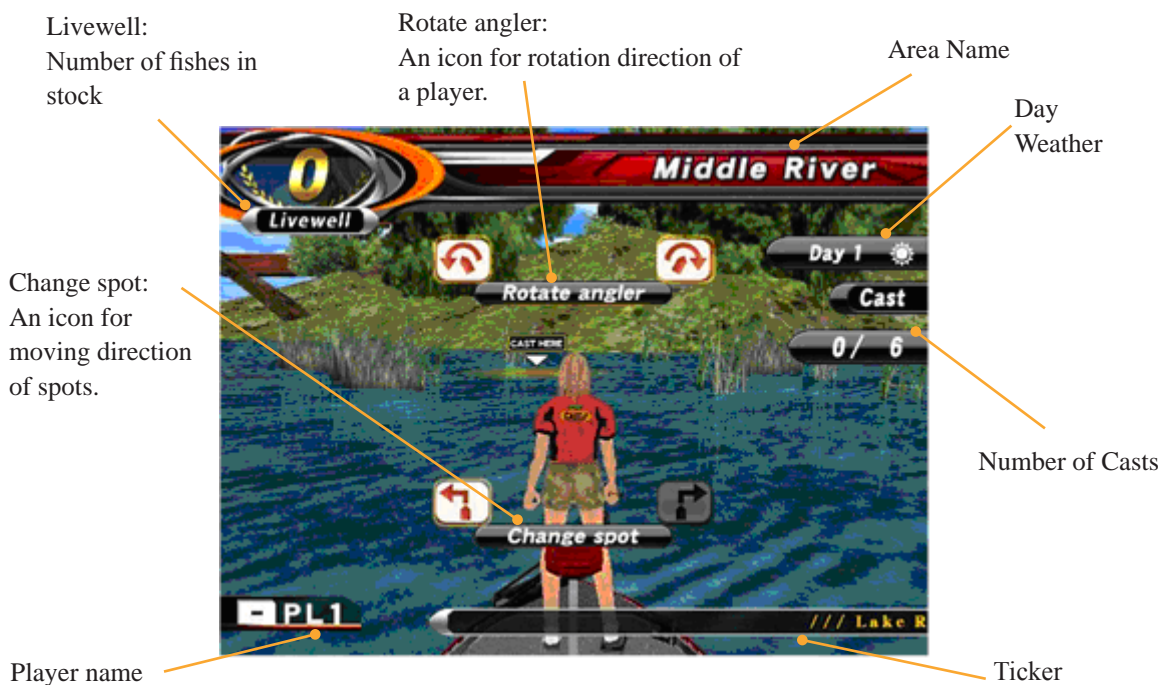

- Start/Overlook

Press Start/Overlook Button in game play to overlook SPOT from high in the sky. Press Rotate Right (left) Button to overlook both sides at this situation. Press Start/Overlook Button again to return to the original condition.

- Rotate Right (Left) Button

Rotate character clockwise and counter clockwise. (45 degree both ways) Icon will gray out when reach to 45 degree.

- Move To Right (Left) Button

There are 3 spots in one area. Press Move To Right (Left) Button to move a spot. Icon will gray out when in the rightmost (leftmost) Spot. (No more move)

- Change lure

A lure a player has is changed by right and left spin of Trackball. If a player swings back, a player can't change a lure until next cast.

- Casting

Backswing is to spin a Trackball backward. (Set position.) Casting is to spin a Trackball forward. (Cast a lure.) There are 4 kinds of casting that has different heights distance and orbit of a lure.

- Overhead cast: Orthodox casting. Throw a rod over a head and cast.
- Sidehand cast: Side throw a rod and cast.
- Backhand cast: Swing side back to other side then Side throw and cast.
- Pitching cast: Pull down a rod point to legs and cast by bounce.

Casting style is decided when Trackball is rotated by following directions in Set position.

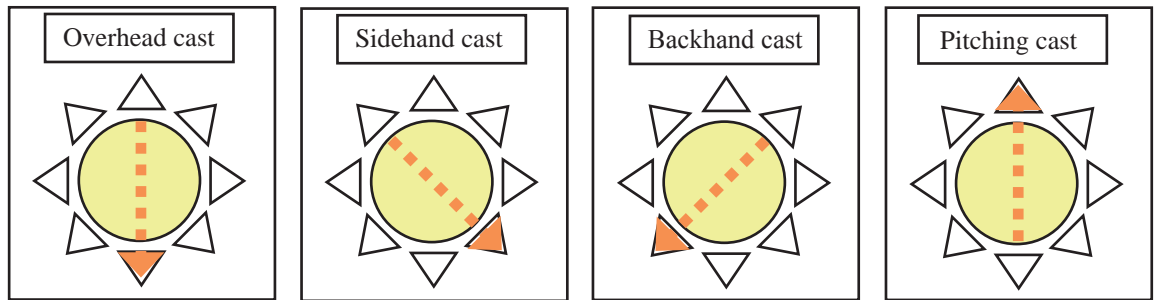

When casting a lure, Roll a trackball as follow directions to changes lure's fly directions.

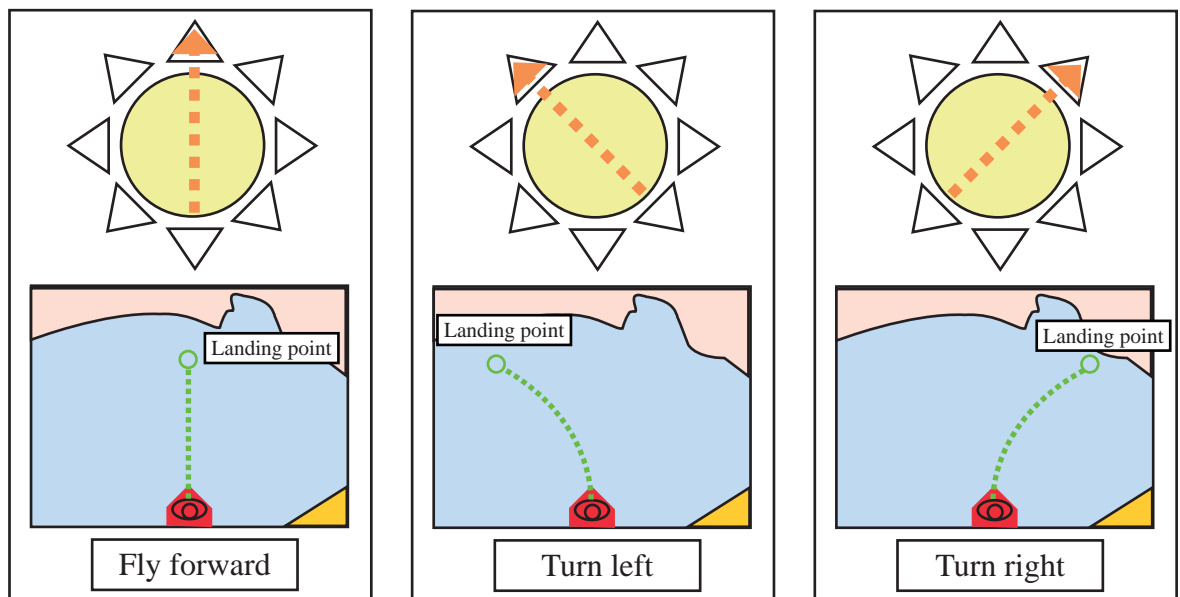

8-3 HOW TO FISH

- Aim at Casting points on the field and cast a lure.
Basically, basses exist in any places in the lake. However, if a player want to catch big bass (heavier bass), a player needs to cast a lure to a place where bigger basses exist.
Big basses exist in Casting point in the lake. If a player aim and cast a lure there, it is possible to catch a big bass.

- Casting point
Casting point consists of 3 layers. There are 3 zones "Awesome", "Great", "Good" from inside. Casting point disappears when a lure enters in once.

- Retrieve (A lure is moved by rolling Trackball)
Casting lure is moved by Trackball. A lure is moved by Trackball and a bass will bites a lure. Lure's speed is different by Trackball's rotating speed. Rolling of Trackball left or right that also move lure left and right.

- Hooking > Rolling Trackball in an arrow direction.
An arrow displays when a bass bites a lure. Hook the bass when rolling Trackball in as arrow direction. An Arrow displays 4 different of directions. (Up, Down, Left and Right) Quick reflection turns the table for Fight Game.

- Fight Game
Once a lure catches a fish, faster and wilder Fight Game starts. Line Tension gauge displays on the screen and an arrow in gauge is moved by Trackball.
Try to stay an arrow in safe zone.
Gauge is shorter with time.
An arrow continues to touch both sides of gauges and game is failed.
An arrow is in SAFE zone and a lamp on the upper gauge lights up.
All lamps light up and Fight Game is success.
An arrow appears with water jump.
A fighting bass is possible to fly out on water.
An arrow appears as same as hooking in water jump.
A player rolls Trackball to arrow directions.
Input correct direction until gauge in an arrow disappears or bass will escape.

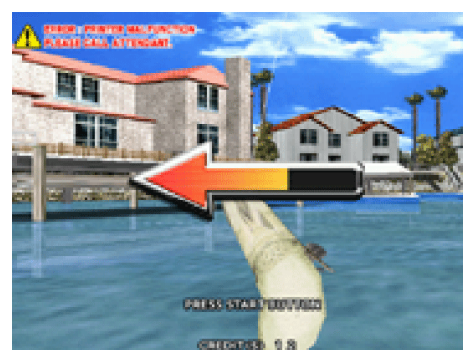
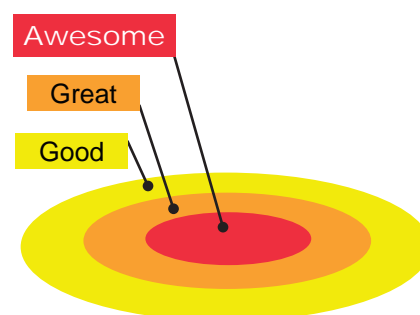

8-4 BONUS GAME

There are 4 kinds of bonus game in this game.

- Bucket O' Lures!!

Contest how many lures a player casts in a basket in limited time.



- Pop'em Carnival

This game is to cast a lure and break a balloon. Contest numbers of broken balloon.



- Through the Stream!

A lure is controlled by Track ball and a lure run through inside rings to go for the goal.



- Long Cast Contest

Cast a lure in abandon and content flying distance.



8-5 SPECIAL LURE

If bonus game is successful, a player gets Special Lure with special effect.

If conditions are perfect and a player clears the game. A player can get Ultimate Lure with more special effect.

- Silver Skater(Pencil bait)

Level up performance of Casting point.



- Blue Fire(Floating Minnow)

Use this lure to add player's own 2 Casting points in the lake.



- Sharp Edge(Spinner bait)

Use this lure and sizes of all Casting points on the field are bigger.



- Hologrub (Grub)

Use this lure and norm time for safe in Fight Game shorten.



Available day

Special lure/Ultimate lure is available in next day a player gets. A player can use Special lure at any times in available day.

8-6 GAME FLOW

Game flow chart from 1st to 3rd day

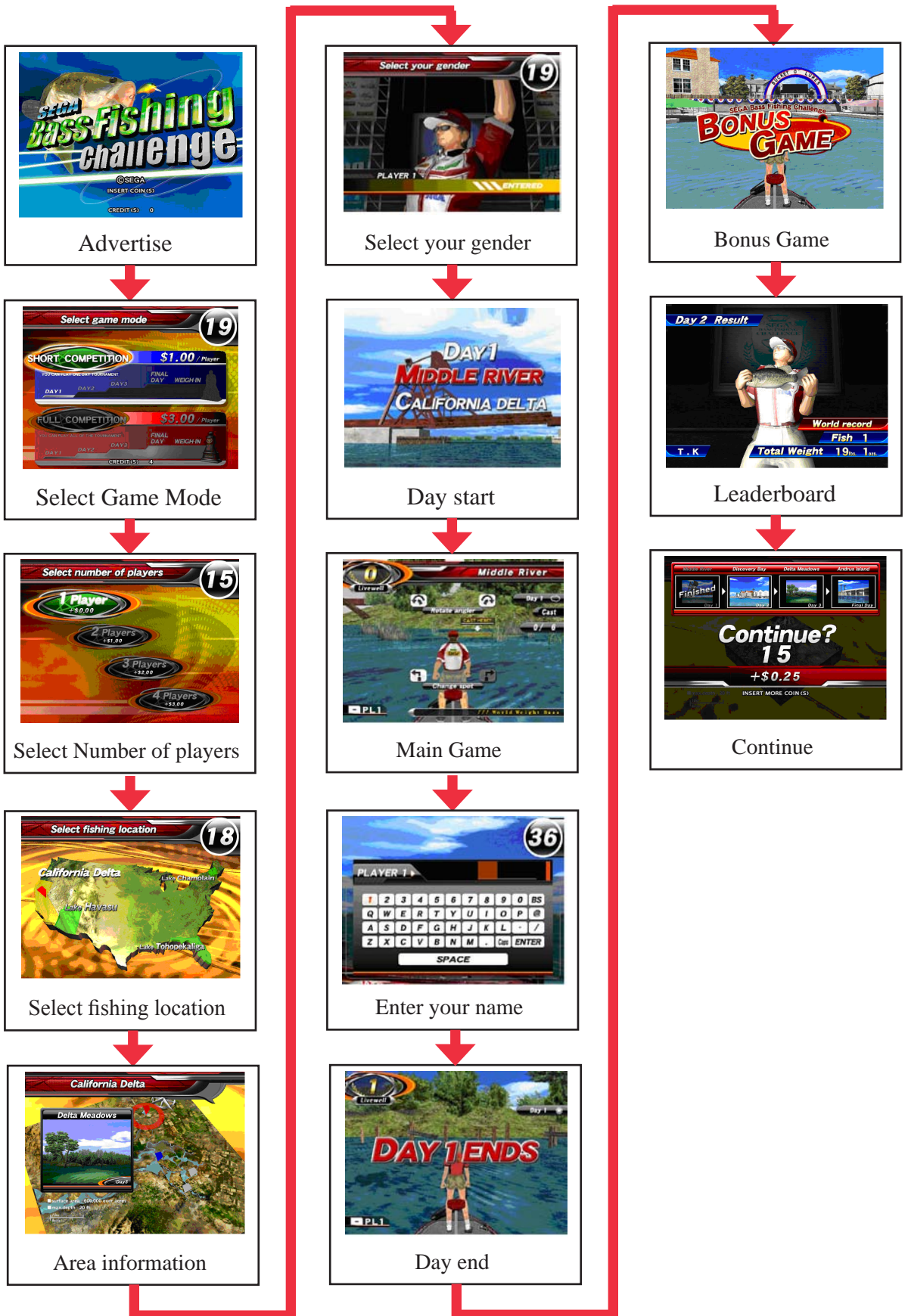

Game flow chart for 4th day

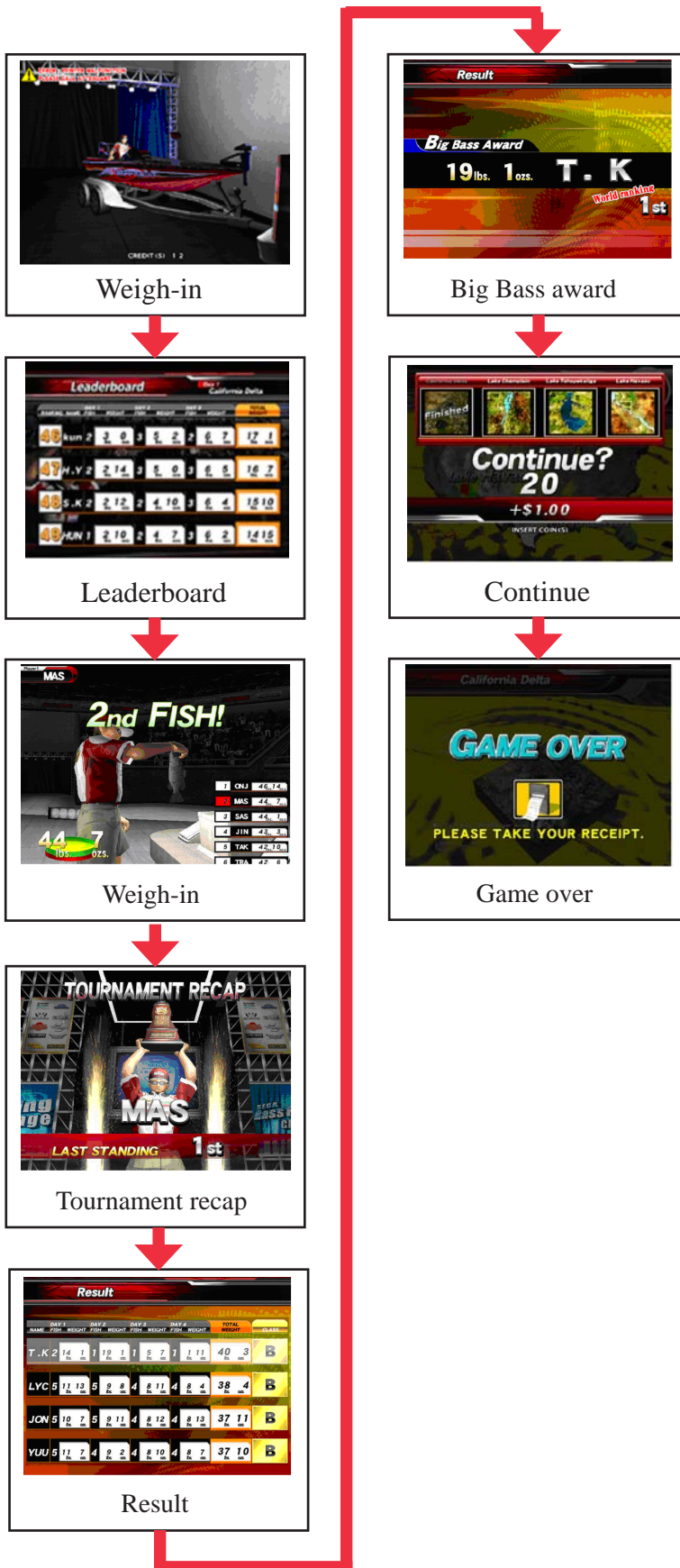

9 SYSTEM MENU

Perform periodic tests and data checks using the TEST/SERVICE button inside the coin door. Follow the instructions in this chapter to conduct checks when the game machine is first installed, when money is being collected, or when the game machine does not operate properly.

Shown below are the tests and screens to be used for different problems.

EXPLANATION OF SYSTEM MENU

ITEMS	DESCRIPTION	
INSTALLATION OF MACHINE	<ol style="list-style-type: none"> 1. Check to ensure display the Information display. 2. Check each Input equipment in the INPUT TEST mode. 3. Check each Output equipment in the OUTPUT TEST mode. 	Chapter 6
PERIODIC SERVICING	<p>Periodically perform the following:</p> <ol style="list-style-type: none"> 1. Ascertain each setting. 2. To test each Input equipment in the INPUT TEST mode. 3. To test each Output equipment in the OUTPUT TEST mode. 	Chapter 12
CONTROL SYSTEM	<ol style="list-style-type: none"> 1. To check each Input equipment in the INPUT TEST mode. 2. Adjust or replace each Input equipment 3. Check the mechanical functions 	Chapter 9,16
MONITOR	In the Monitor Adjustment mode, check to see if Monitor (Projector) adjustments are appropriate.	Chapter 6
I/O BOARD	Check to ensure Information display. Speaker test	Chapter 9
DATA CHECK	Check such data as game play time and histogram to adjust the difficulty level, etc.	Chapter 9

9-1 SWITCH UNIT AND COIN METER

WARNING

Never touch places other than those specified. Touching places not specified can cause electric shock and short circuit accidents.

CAUTION

Be careful that a finger or hand does not get caught when opening/closing the coin chute door.

IMPORTANT

- When you enter the Test Mode, fractional coin and bonus adder data is erased.
- Adjust the sound to the optimum volume, taking into consideration the environmental requirements of the installation location.

SWITCH UNIT

Open the coin door, and the switch unit will appear. (Location of switch unit is different place depend of you cabinet)
The functioning of each SW is as follows:

TEST Button (TEST):

Enter in SYSTEM menu. It is used as a cursor move button in System menu.

SERVICE Button (SERVICE):

Insert a credit for service without turning up a coin meter. It is used as Select Button in System menu.

COIN METER

Open the Coin Door by using the key to have the Coin Counter appear. (Location of Coin meter unit is different place depend of you cabinet)

9-2 SYSTEM MENU

IMPORTANT

- When changing the game configuration, changes will not take effect until the Game Test Mode properly after configuration changes. Be sure to exit the Game Test Mode properly after configuration changes.
- Do not configure the game in ways not described in this text. It is possible that the game will not function properly.

Press the TEST Button to display the following SYSTEM TEST MENU after powering on the unit.



Use the TEST Button to move the cursor and the SERVICE Button to select. It is impossible to select gray items (COIN SETTINGS and NETWORK SETTINGS).

After test or setting are complete, move the cursor to EXIT and press Service Button to return Game Advertisement screen.

9-3 TEST MODE

9-3-1 TEST MODE MENU

Select GAME TEST MODE in System Menu screen to display Game Test Menu.

- 1) Press the TEST Button to move the cursor.
- 2) Move the cursor to the desired test item, and press the Service Button to return each test screen.
- 3) Move the cursor to EXIT after test is complete and press the TEST Button to return to System Menu.



9-3-2 COLOR TEST

Select COLOR TEST to display monitor color test.

Press the Service Button to return the TEST MODE menu after test is complete.



9-3-3 CROSS HATCH

Select CROSS HATCH to display monitor display size test.

Press the Service Button to return the TEST MODE menu after test is complete.

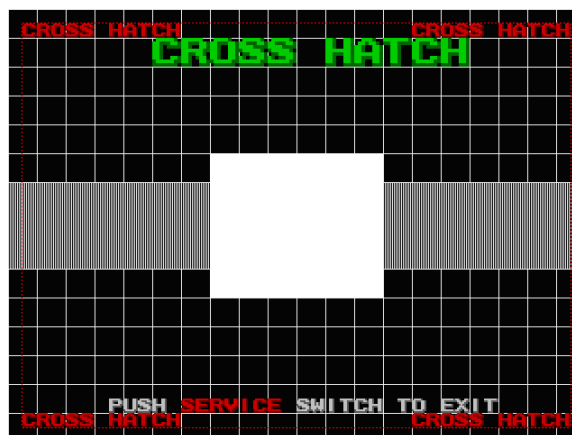

9-3-4 SOUND TEST

Select SOUND TEST to display the monaural sound test screen, when setting “MONO” in AUDIO MODE of SYSTEM SETTINGS.

- 1) Select “START” to output sound.
- 2) Select “STOP” to stop sound.
- 3) Select “EXIT” to return to TEST MODE screen after test is complete..

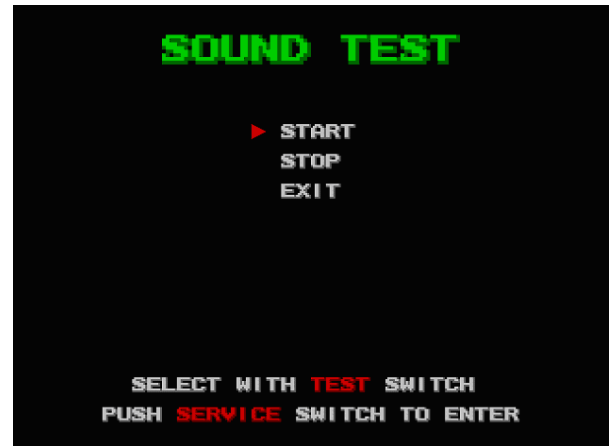

Select SOUND TEST to display stereo sound test screen, when setting “STEREO” in “AUDIO MODE” of SYSTEM SETTINGS of CONFIGURATION..

- 1) Select “RIGHT” to output sound from right speaker.
- 2) Select “LEFT” to output sound from left speaker.
- 3) Select “CENTER” to output sound from both left & right speakers.
- 4) Select “STOP” to stop sound.
- 5) Select “EXIT” to go back to TEST MODE screen after test is complete.

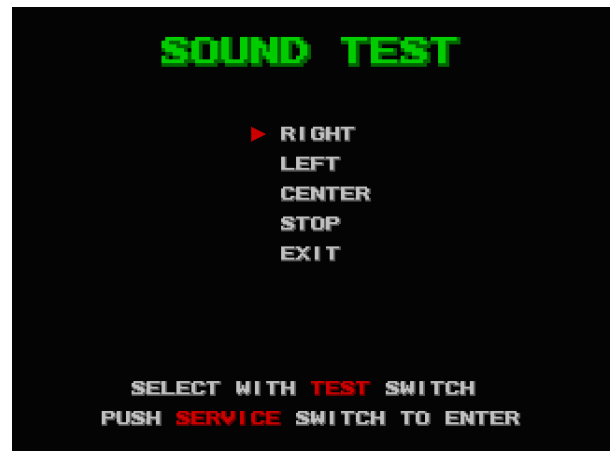

9-3-5 MEMORY TEST

Select MEMORY TEST to display Main PCB RAM test.

- 1) Press the TEST Button to start to R/W RAM test. This test can't be canceled until it is finished.
- 2) Press the Service Button to return the TEST MODE menu screen after test is complete.



9-4 CONFIGURATION



Content set in CONFIGURATION is recorded when selecting “SAVE&EXIT”. Setting contents are invalid when power is off before “SAVE&EXIT”.

9-4-1 CONFIGURATION

Select CONFIGURATION from the SYSTEM menu and CONFIGURATION menu screen is displayed.

1) Press the TEST Button to move the cursor.
2) Move the cursor to the desired test item, and press the Service Button to move to each setting screen.
Contents of “COMMUNICATION SETTING” are unavailable when game has no COMMUNICATION feature.

3) Move the cursor to EXIT and press the TEST Button to return to the System Menu screen after setting is complete.

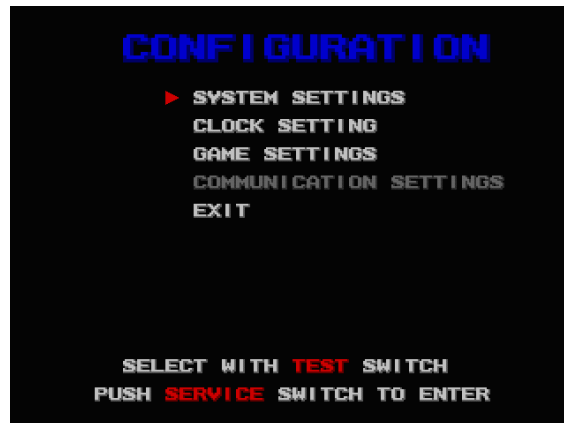

9-4-2 SYSTEM SETTINGS

Select SYSTEM SETTINGS to display the basic setting screen.

Use the Test Button to move the cursor to setting items and the Service Button to change setting value.

AREA:

Set the operation area; NORTH AMERICA or OTHER.

LANGUAGE: ENGLISH

ADVERTISE SOUND:

Set sound in Advertisement; “ON” or “OFF”

AUDIO MODE:

Set sound output; “MONO” or “STEREO”

SOUND VOLUME:

Set sound volume.; from 0 to 15

Move the cursor to “SAVE&EXIT” after setting change is complete. Press the Service Button to return to the SYSTEM menu after setting is saved.

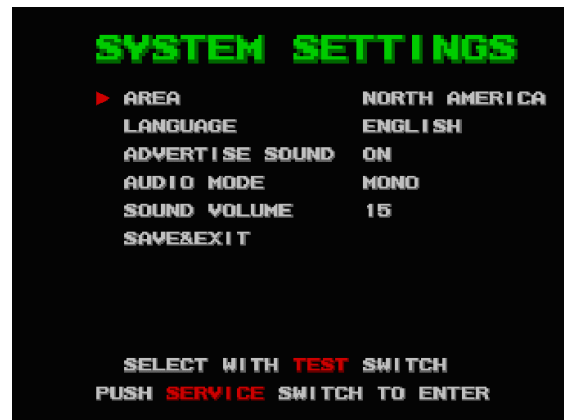

9-4-3 CLOCK SETTINGS

Select CLOCK SETTINGS to display setting date and hour of Main PCB screen. Use the TEST Button to move the cursor and the SERVICE Button to change the set value.

YEAR: Set a year. (From 2002 to 2038.)

MONTH: Set a month. (From 1 to 12.)

DAY: Set a day. (From 1 to 31.)

HOUR: Set time. (From 0 to 23.)

MINUTE: Set minutes. (From 0 to 59.)

Move the cursor to “SAVE&EXIT” after setting change is complete. Press SERVICE Button to return to SYSTEM menu after setting is saved.



9-4-4 GAME SETTINGS

Select GAME SETTINGS to display game setting screen.
Use the TEST Button to move the cursor and the SERVICE Button to change the set value.

FULL COMPETITION: Enable = Able to select FULL COMPETITION or SHORT COMPETITION. Disable = SHORT COMPETITION only.

DIFFICULTY LEVEL: 5 difficulty levels available. (Adjust by Size of Casting Point, Display time of Hook arrow, Difficulty of Fight game and Display time of arrow in Air jump.)

VERY EASY->EASY->NORMAL->HARD->VERY HARD

NUMBER OF CASTS: Number of cast in one day. (1 to 10)

CREDIT SETTINGS: Set play fee. Refer to Chapter 9-4-4-1.

PRINTER SETTINGS: Set printer settings. Refer to Chapter 9-4-4-2



Move the cursor to “SAVE&EXIT” after setting change is complete. Press the SERVICE Button to return to SYSTEM menu after setting is saved.

9-4-4-1 CREDIT SETTINGS

Select CREDIT SETTINGS to display play fee setting screen.
Use the TEST Button to move the cursor to the set item and the Service Button to change the set value.

GAME MODE:

Set GAME MODE. (“NORMAL” or “FREE PLAY”)

NORMAL PLAY: Set normal play fee. (1to 24)

CONTINUE PLAY:

Set continue play fee. (1to 24) It is impossible to set larger than NORMAL PLAY value.

FULL COMPETITION: Set Full competition play fee. (1 to 24) It is impossible to set smaller than NORMAL PLAY value.

CURRENCY TYPE: Set currency. (DOLLAR or CREDIT)

Move the cursor to “SAVE&EXIT” after setting change is complete. Press the Service Button to return to the SYSTEM menu after setting is saved.

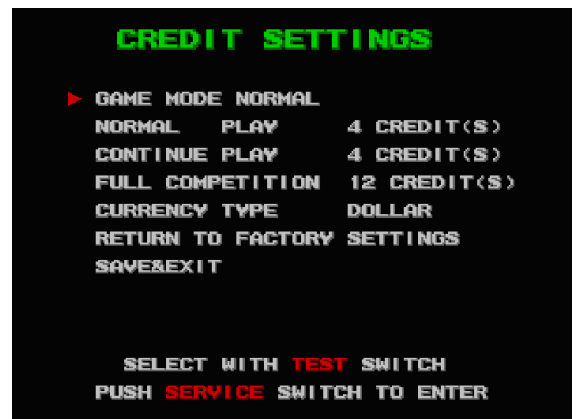

9-4-4-2 PRINER SETTINGS

Select PRINTER SETTING to display printer setting screen. Use the TEST Button to move the cursor to the set item and the Service Button to change the set value.

PRINTER:

Set to using a printer or not. (DISABLE or ENABLE)

PRINT TEST: Print out receipt. (ON or OFF)

TOURNAMENT SETTINGS:

Set TOURNAMENT SETTING. Refer to Chapter 10 TOURNAMENT.

Move the cursor to “SAVE&EXIT” after setting change is complete. Press the Service Button to return to the SYSTEM menu after setting is saved.



9-5 BOOKKEEPING

9-5-1 BOOKKEEPING

Select BOOKKEEPING to display contents of operation status. Data is saved in SRAM of Main PCB. Use the Test Button to move the cursor to check items and Service Button to display.

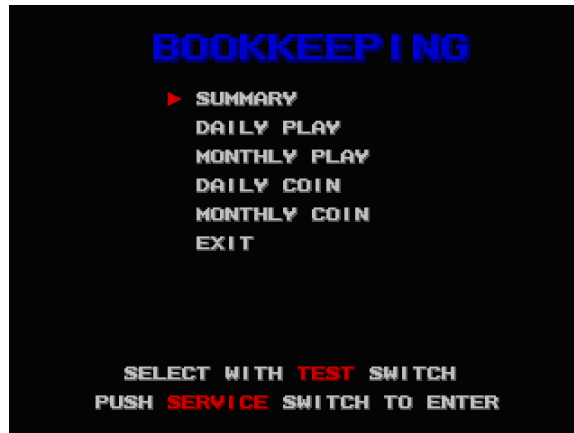

Move the cursor to “EXIT” after checking operation status and press Service Button to return to System menu.

9-5-2 SUMMARY

Select SUMMARY to display data summary.

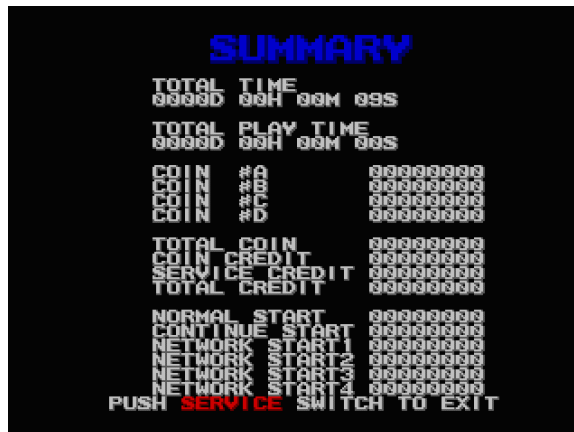

TOTAL TIME:	The time when game is powered on.
TOTAL PLAY TIME:	Total play time
COIN #A:	Coin numbers in Coin Chute 1
COIN #B:	Coin numbers in Coin Chute 2
COIN #C:	Coin numbers in Coin Chute 3
COIN #D:	Coin numbers in Coin Chute 4
TOTAL COIN:	Total Coin numbers from Coin chute 1 to 4
COIN CREDIT:	Credit numbers by coin inserting.
SERVICE CREDIT:	Credit numbers by Service Button
TOTAL CREDIT:	Total credit numbers
NORMAL START:	Usual game play numbers
CONTINUE START:	Play numbers by continue
NETWORK START1:	This is not used in this game.
NETWORK START2:	This is not used in this game.
NETWORK START3:	This is not used in this game.
NETWORK START4:	This is not used in this game.

Press Service Button to return to BOOKKEEPING menu screen after checking data.

9-5-3 DAILY PLAY

Select DAILY PLAY to display daily play checking screen. Daily play number, continue number, average play time display.

After checking, press Service Button to display next page. Return to BOOKKEEPING menu when last page displayed.

DAILY PLAY DATA1

DATE		PLAY	CONT	AVE PLAY TIME		
5/	1/09	MON	0	0	0h	0m 0s

PUSH **SERVICE** SWITCH TO EXIT

9-5-4 MONTHLY PLAY

Select MONTHLY PLAY to display monthly play checking screen. Monthly play number; continue number and average play time display.

After checking, press the Service Button to display next page. Return to BOOKKEEPING menu screen when last page displayed.

MONTHLY PLAY DATA1

DATE	PLAY	CONT	AVE PLAY TIME		
Jan .09	0	0	0h	0m	0s
TOTAL	0	0	0h	0m	0s

PUSH **SERVICE** SWITCH TO EXIT

9-5-5 DAILY COIN DATA

Select DAILY COIN DATA to display daily coin insert checking screen. Daily coin insert number of coin chute 1 to 4 and credit number by Service Button display.

After checking, press the Service Button to display next page. Return to BOOKKEEPING menu screen when last page displayed.

DAILY COIN DATA1

DATE		Co #A	Co #B	Co #C	Co #D	SRV
5/	1/09	MON	0	0	0	0

PUSH **SERVICE** SWITCH TO EXIT

9-5-6 MONTHLY COIN DATA

Select MONTHLY COIN DATA to display monthly coin insert checking screen. Monthly coin insert number of coin chute 1 to 4 and credit number by Service Button display.

After checking, press Service Button to display next page. Return to BOOKKEEPING menu when last page displayed.

MONTHLY COIN DATA1

MONTH	Co #A	Co #B	Co #C	Co #D	SRV
Jan .09	0	0	0	0	0
TOTAL	0	0	0	0	0

PUSH **SERVICE** SWITCH TO EXIT

9-6 BACKUP CLEAR

9-6-1 BACKUP CLEAR

Select BACKUP CLEAR to display the following screen. Use the Test Button to move the cursor to clear items and Service Button to decide.

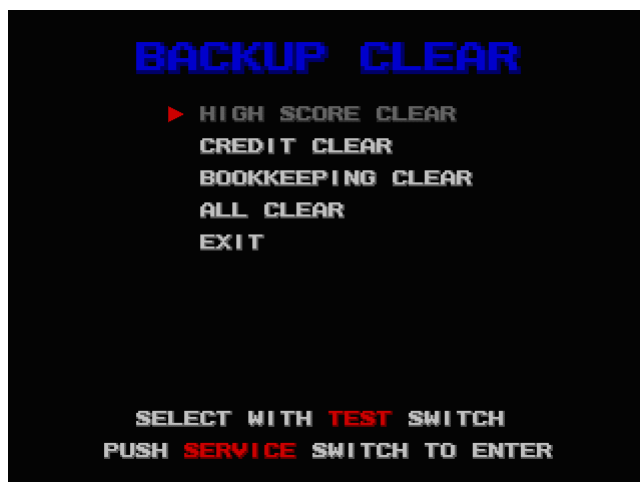

After data is clear, move the cursor to "EXIT" and press Service Button to return System menu.

9-6-2 HIGH SCORE CLEAR

Select HIGH SCORE CLEAR to display the following screen. Use the Test Button to move the cursor “YES” (Enter) or “NO” (Cancel) and Service Button to decide and return to BACKUP CLEAR menu.



9-6-3 CREDIT CLEAR

Select CREDIT CLEAR to display the following screen. Use the Test Button to move the cursor “YES” (Enter) or “NO” (Cancel) and Service Button to decide and return to BACKUP CLEAR menu.

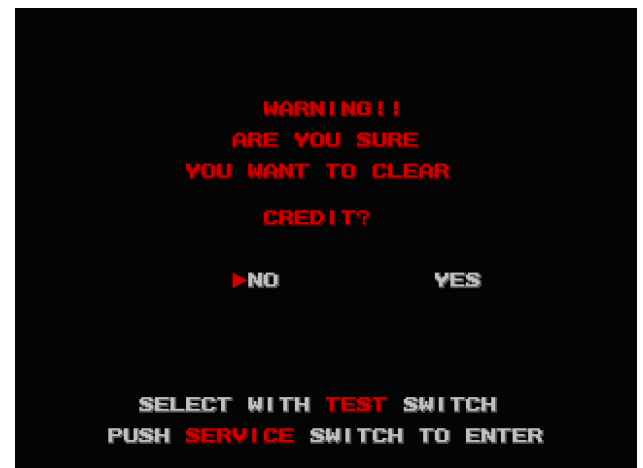

9-6-4 BOOKKEEPING CLEAR

Select BOOKKEEPING CLEAR to display the following screen. Use Test Button to move the cursor “YES” (Enter) or “NO” (Cancel) and Service Button to decide and return to BACKUP CLEAR menu.

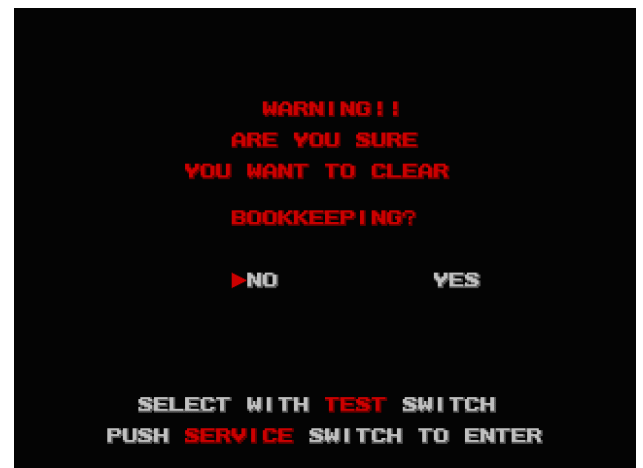

9-6-5 ALL CLEAR

Select ALL CLEAR to display the following screen. Use the Test Button to “YES” (Enter) or “No” (Cancel) and the Service Button to decide and return to BACKUP CLEAR menu.



10 TOURNAMENT

10-1 TOURNAMENT

STOP IMPORTANT

- Opening time of Tournament is based on Chapter 9-4-3, CLOCK SETTING, so input correct time in CLOCK SETTINGS.

10-1-1 ABOUT TOURNAMENT MODE

New object may appear in water instead of Black bass when TOURNAMENT MODE is set. SPECIAL CASTING POINT will appear then cast lure in there, succeed fight game to get new object.

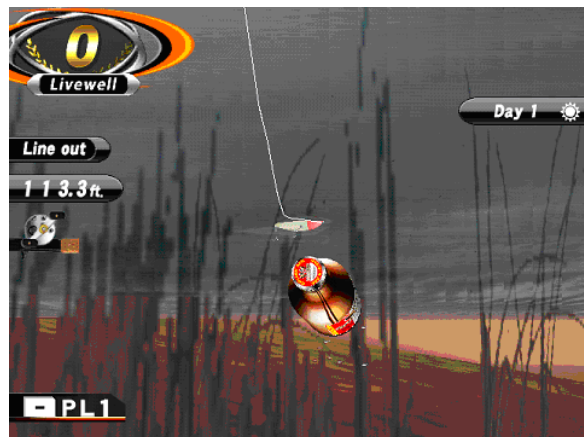

TABLE

PRINTER	TOURNAMENT MODE	PRINT METHOD	PRINT OUT
ENABLE	ENABLE	ALWAYS	Print out results for all players.
		WINNER ONLY	Print out a result for only a player who catches an object.*
	DISABLE	ALWAYS	Print out results for all players.
		WINNER ONLY	Print out results for all players.
DISABLE	ENABLE	ALWAYS	Do not print out.
		WINNER ONLY	Do not print out.
	DISABLE	ALWAYS	Do not print out.
		WINNER ONLY	Do not print out.

*** ATTENTION:**

No object appears in screen when Tournament day is over. (Still "Winner Only" setting is enable but player can not fish the object and no result print out.)

If need print out result, following choice.

- Re-set up Tournament day in setting.
- Or Disable TOURNAMENT MODE.
(Print out result to all player when disable the Tournament mode.)

IMPORTANT

- Controls in TOURNAMENT SETTING screen are below.
- Roll Trackball forward and backward to move cursor up and down.
- Roll Trackball left and right to change numerical value.
- Start Button, Move to right point button, Move to Left point button, Rotate right button, Rotate left button are also used to change numerical value of each setting, open other menu if available.

10-1-3 TOURNAMENT SETTINGS

Set various of Tournament setting in TOURNAMENT SETTINGS screen.



- TOURNAMENT MODE:** Select that the Tournament is held or not. ENABLE to appear object for tournament then player able to catch an object when cast a lure in Special casting point. (ENABLE or DISABLE)
- PRINT METHOD:** Select print out method. Print a receipt out with result to All player or Only player who catch an object in TOURNAMENT. (ALWAYS or WINNER ONLY)
- WINNING TARGET:** Set a size of Special Casting point. (SMALL MEDIUM LARGE)
- TOURNAMENT AD.:** Decide whether setting screen in TOURNAMENT AD. EDITOR (Refer to 10-3) displays or not. (HIDE or SHOW)
- START DAY:** Set the date of tournament mode starting. Refer to 10-2.
- END DAY:** Set the date of tournament mode ending. Refer to 10-2.
- SELECT MERCHANDISE:** Set an object for tournaments. Refer to 10-3.
- TOURNAMENT AD. EDITOR:** Set Tournament beginning and ending period and texts in Advertise screen etc. Refer to 10-4.
- PRINTABLE TEXT EDITOR:** Set texts printed out. Refer to 10-5.
- PLAY LOG:** Confirm play records and printed result. Refer to 10-6.
- RETURN TO FACTORY SETTINGS:** All items in TOURNAMENT return to factory setting situation.

10-1-4 RETURN TO FACTORY SETTINGS:

If selected RETURN TO FACTORY SETTINGS, displays the screen which confirms whether TOURNAMENT SETTINGS items return to factory settings.



10-2 START DAY, END DAY

Set a day of start and end in TOURNAMENT.

During only this term, a prize setting in SELECT MERCHANDISE (10-3) appears.

END DAY can't be set before START DAY.

Rolling Trackball forward and backward is to select items. Rolling Trackball right and left is to change value. (Or it is possible to change value by using Start Button, Move to right point button, Move to Left point button, Rotate right button and Rotate left button.)

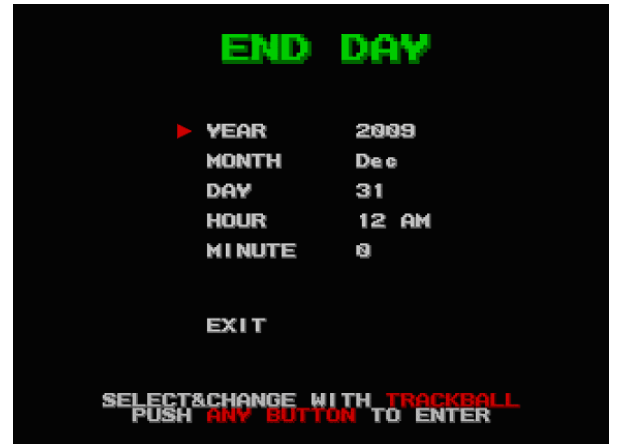
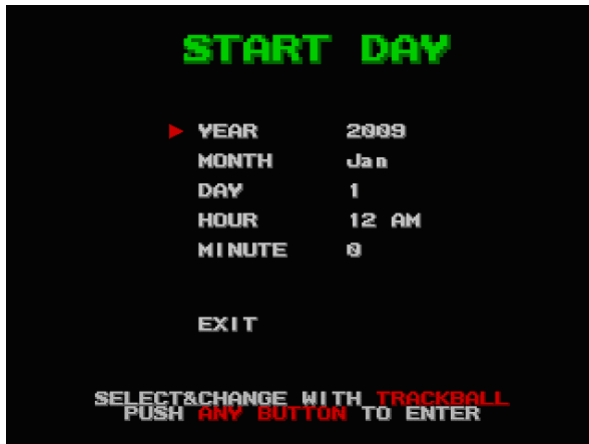

- | | |
|---------|------------------------------------|
| YEAR: | Set a year. (From 2002 to 2038.) |
| MONTH: | Set a month. (From Jan. to Dec.) |
| DAY: | Set a date. (From 1 to 31.) |
| HOUR: | Set an hour. (From 1 AM to 12 PM.) |
| MINUTE: | Set minutes. (From 0 to 59.) |

10-3 SELECT MERCHANDISE

Select other objects than basses. Special Casting Point displays during only Tournament and a player can cast and catch it.

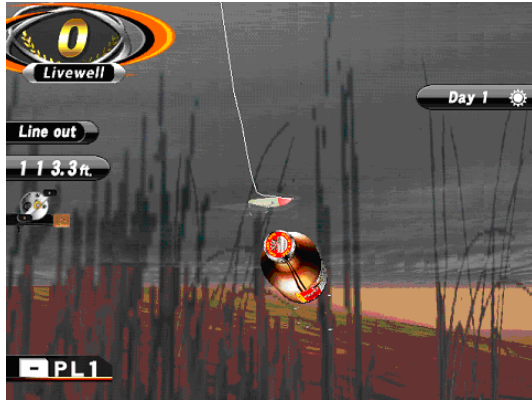

10-3-1 SELECT MARCHANDISE

Select an object to roll Trackball right and left. Select from BOTTLE, CAN, FOOD, MESSAGE BOTTLE or WIN.

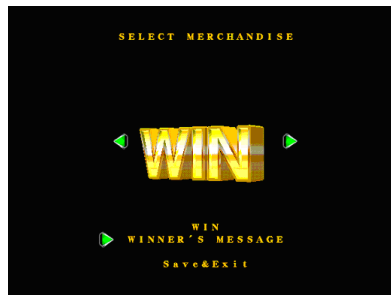
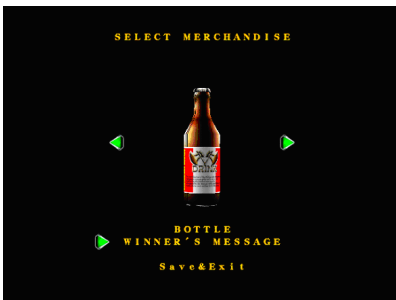

10-3-2 WINNER'S MESSAGE

Input texts that will display when a player catches an object. Maximum 15 letters are possible to input. Default text is "You are the winner!"



10-3-3 SAVE & EXIT

Save current setting and return to TOURNAMENT SETTINGS screen.

10-4 TOURNAMENT AD. EDITOR

Set a screen and text that will display in the Tournament announcement.

5 kinds of screens are ready. Select display screen to roll Trackball right and left. This screen is alterable at any time.

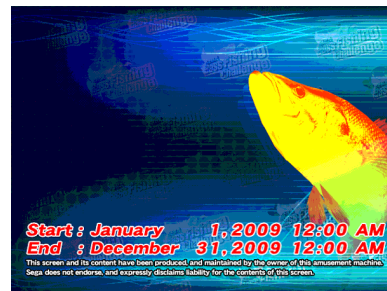
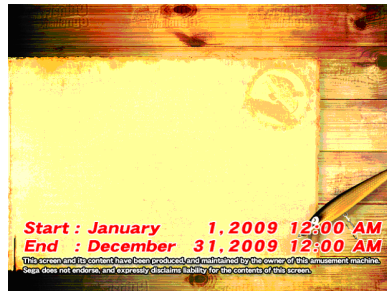

10-4-1 CUSTOMIZE TITLE

Input Tournament title. Maximum 15 letters are possible to input.



10-4-2 CUSTOMIZE MESSAGE

Input Tournament texts. Maximum 15 letters x 5 lines are possible to input. (75 letters)



10-4-3 PREVIEW

Confirm the setting screen that you set and edit.

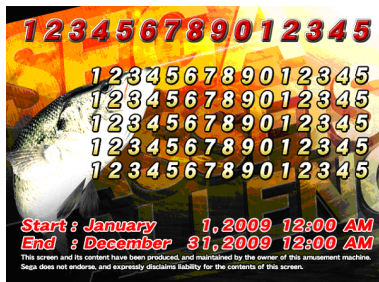

10-4-4 SAVE & EXIT

Save the setting and return to the Tournament screen.

10-5 PRINTABLE TEXT EDITOR

Set printed contents, if PRINTER is "Enable."

Select contents by rolling Trackball forward and backward then START button to decide.

Software key board displays then select input texts by Trackball. START button, Move to left (right) point button or Rotate left (right) button to decide.

10-5-1 SETTING

Configurable contents are as follow. Instead of contents title, free to input any letters.

Maximum 30 letters are possible to input each contents. Not printed letters when no input.

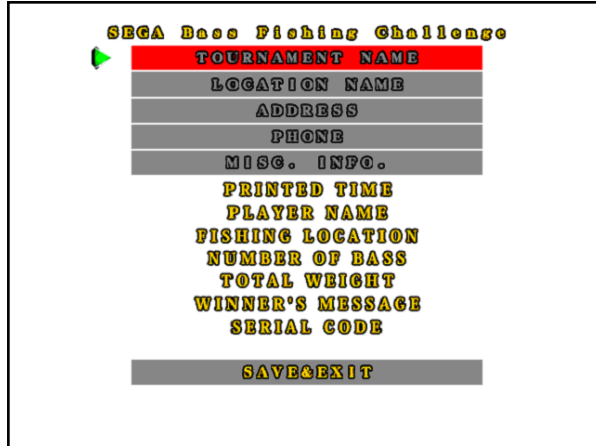
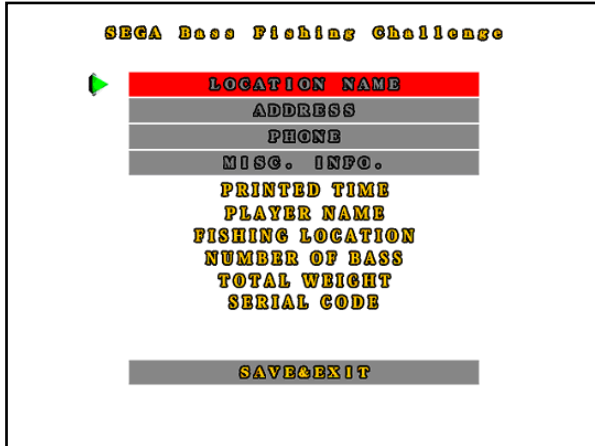

TOURNAMENT NAME:

Input the Tournament name. Set to display

TOUNAMENT SETTINGS/TOURNAMET MODE

or not. > ENABLE (Display) DISABLE (Nondisplay)

10-1-3 TOURNAMENT SETTINGS.

LOCATION NAME: Input location name.

ADDRESS: Input location address.

PHONE: Input location telephone number.

MISC. INFO.: Input Web address and other information.



10-6 PLAY LOG

The history and the print result of the game are displayed.

Confirm whether a receipt is printed out by this machine for real or not and print time and objects which a player gets in tournaments. (Maximum 100 subjects in past.)



10-7 ABOUT PRINTER

10-7-1 PRINT OUT



10-7-2 USUAL PRINT RESULT

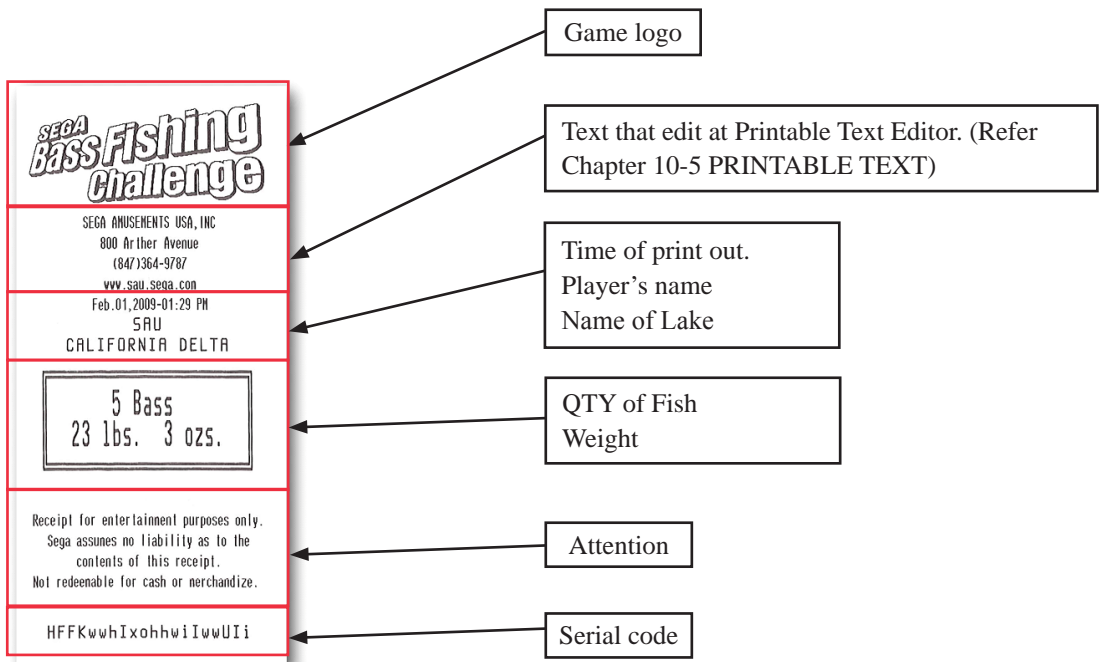

10-7-3 PRINT RESULT WHEN TOURNAMENT IS HELD

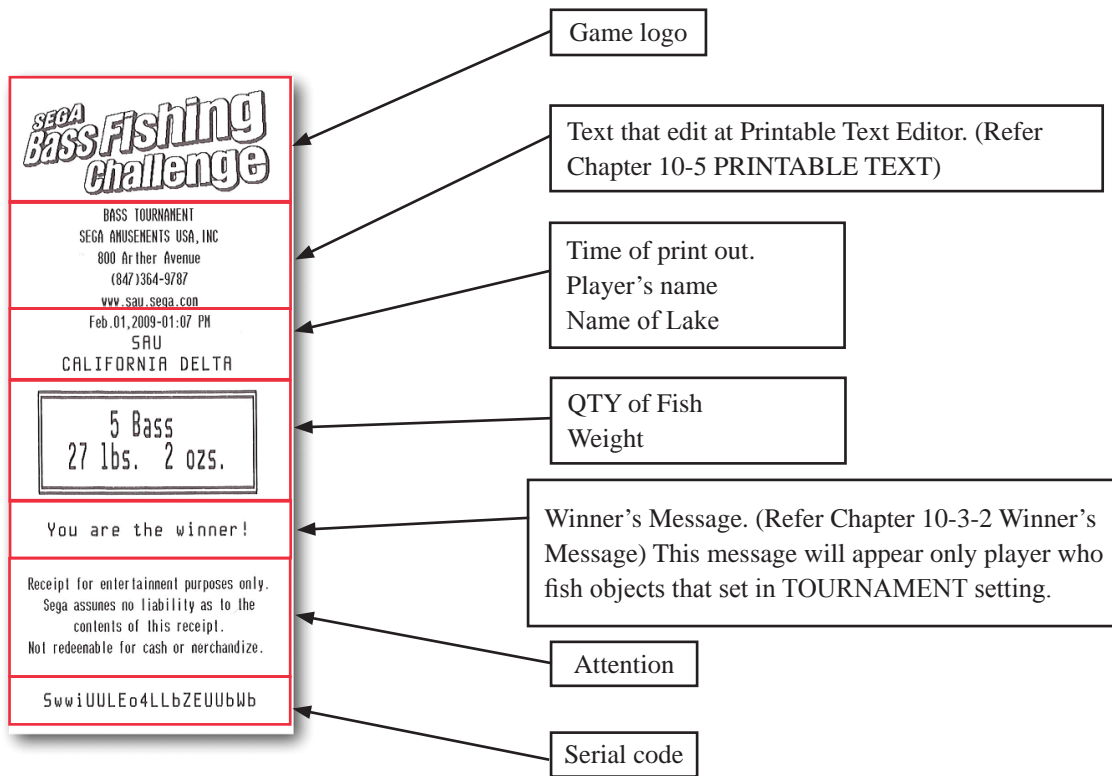

10-7-4 EXCHANGE PROCEDURE OF PAPER ROLL

1.4 MAINTENANCE

1.41 Changing the paper roll

Every time you change the paper, referred to fig. 1.4, need to check as follows :

- Lift the wicket relative to paper roll compartment, and check that there are no scraps of paper at the area indicated with a) letter near the printing head. If there are, remove the scraps before proceeding with any other operation.

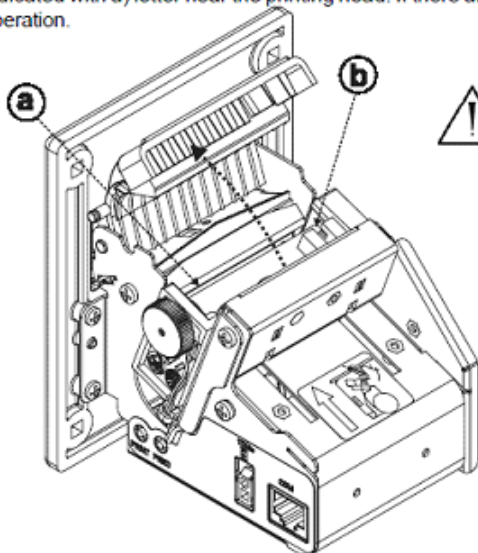

(Fig.1.4)



WARNING

Periodically remove accumulated paper dust from the drag paper roll and the area around the paper outfeed sensor (see fig. 1.4 in the he points indicated with b letter). To clean, do not use harsh chemical solvents; the use of a soft, alcohol-moistened cloth is recommended.

- 1) Open printer door.
- 2) Position the paper roll (1) so that it rotates in the direction shown.
- 3) Insert the end of the paper roll in the print mechanism (2) and wait until the roll loads automatically.
- 4) Remove the ticket from the mouth paper output.

- To change the paper roll in the printer, proceed as follows (see the fig. 1.5) :
- 1) Position the paper roll (1), so that it rotates in the direction shown (fig.1.5);
 - 2) Insert the end of the paper roll in the print mechanism (2) and wait until the roll loads automatically;
 - 3) Remove the ticket from the mouth paper output;

(Fig.1.5)

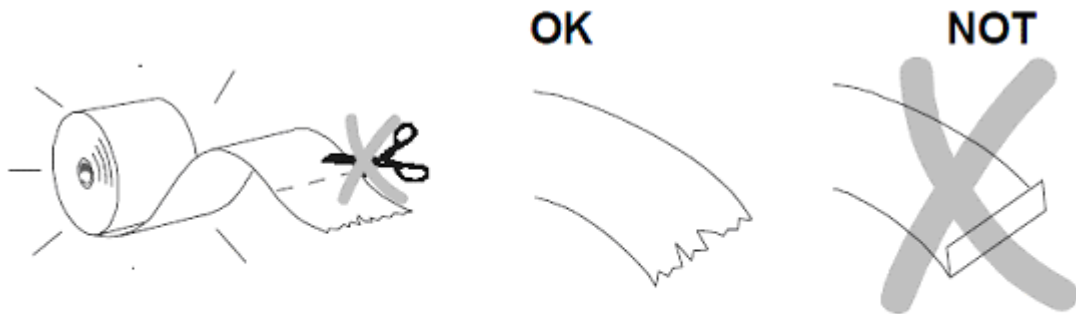
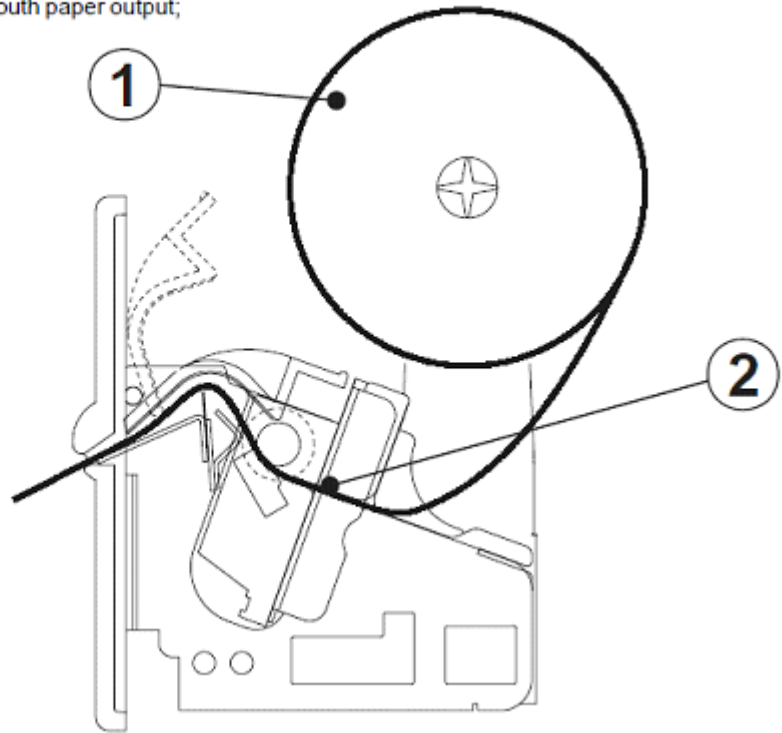

(Fig.1.6)



WARNING
Before inserting the paper,
ensure that it isn't cut evenly.

Must use attached of Control Discs when set a Paper roll.

Using the control discs

Assembly the control discs with the paper roll pivot as shown in the fig. A.11.



⁽²⁾ **NOTE:** The model indicated in fig. A.11 is indicative to show the assembly so the following informations are corrects for all models.

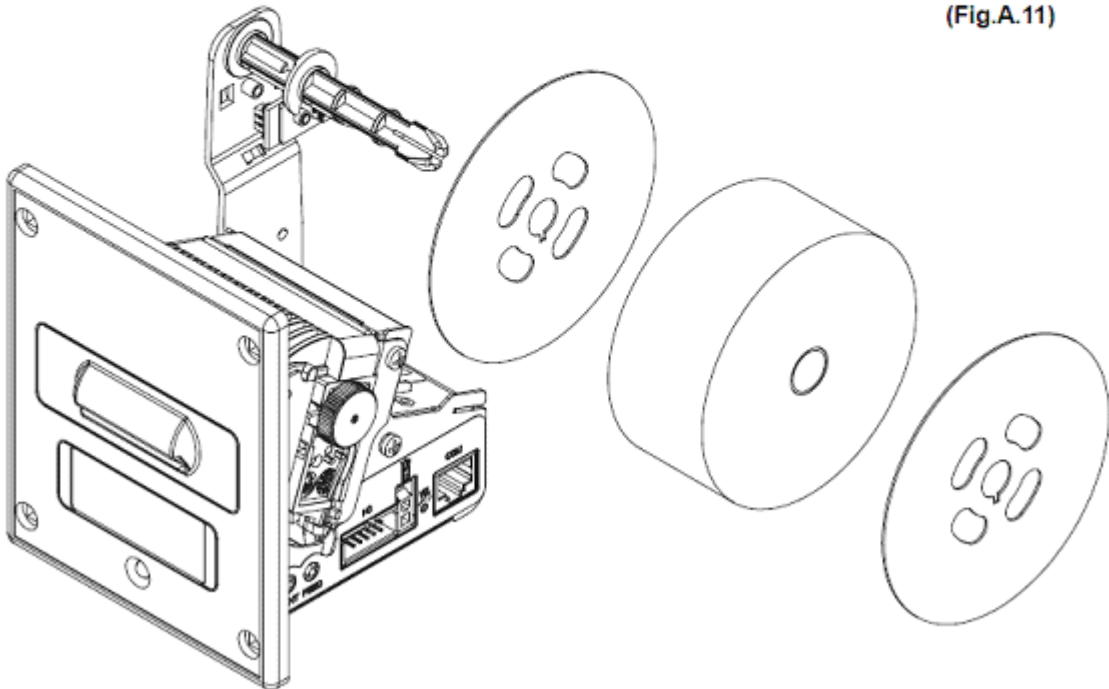

10-7-5 ERROR DISPLAY AND CORRESPONDENCE

Error message will display on left top of screen when printer error occurs. Error message will disappears when solve problem.



10-7-6 PRINTER MALFUNCTION

Error message will display on left top of screen when printer is malfunction. Power off the cabinet, check connection of printer cable then re-power on the cabinet.

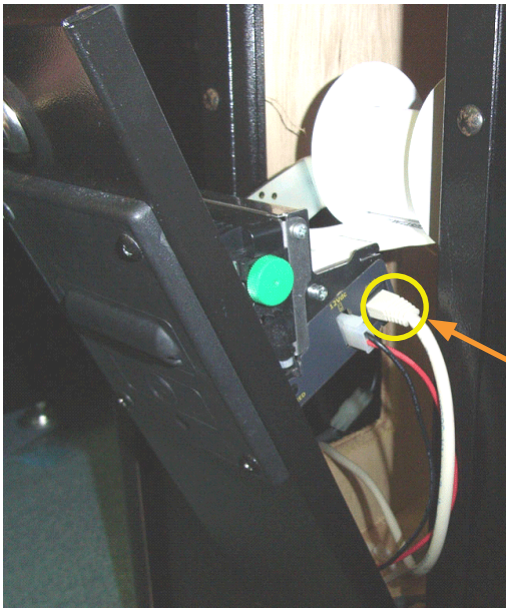

Make sure DO NOT disconnect or loose these connectors.

10-7-7 OUT OF PAPER

Error message will display when the Paper roll is empty. Open printer Door then fill the Paper roll.

NOTE: There is possibility to change “OUT OF PAPER” error message to “PRINTER MALFUNCTION” when leaving “OUT OF PAPER” message for long time. Check Paper roll even PRINTER MALFUNCTION error occurred.

Play result is not printed out after OUT OF PAPER occurred.

Refer Chapter 10-7-4 EXCHANGE PROCEDURE OF PAPER ROLL.



10-7-8 PAPER JAM

Error message will display when paper jam occurred on printer unit. Open printer door then remove paper roll which jammed.

NOTE: There is possibility to change “PAPER JAM” error message to “PRINTER MALFUNCTION” when leaving “PRINTER JAM” message for long time. Check Paper roll jam even PRINTER MALFUNCTION error occurred.

PAPER JAM error message will display when piece of paper is leaving inside of printer. Check and remove piece of paper from Printer then fill the Paper roll to the printer.

Play result is not printed out after OUT OF PAPER occurred.



11 PERIODIC INSPECTION

The items listed below require periodic check and maintenance to retain the performance of this machine and to ensure safe business operation.

When handling the controller, the player will be in direct contact with it. In order to always allow the player to enjoy the game, be sure to clean it regularly. Also, it is advisable to provide wet tissue, etc. available for player use.

⚠ WARNING

- **Once a year, check to see if power cords are damaged, the plug is securely inserted, dust is accumulated between the socket outlet and the power plug, etc. Using the product with accumulated dust in the interior may cause fire or electric shock.**
- **Never use a water jet, etc. to clean the inside and outside of the cabinet. If wetness occurs for any reason, do not use the product until it has completely dried.**
- **Once a year, request the office shown on this manual or the dealer from whom the product was originally purchased to perform the internal cleaning. Using the product with accumulated dust in the interior may cause fire or other accidents. Note that you are liable for the cost of cleaning the interior parts.**
- **There is the danger of accidents involving electrical shorts circuits or fire caused by factors such as the deterioration of insulation in electrical and electronic equipment over time. Check that there are no abnormalities such as odors from burning.**

Cleaning the Cabinet Surfaces

When the cabinet surfaces are badly soiled, remove stains with a soft cloth dipped in water or diluted (with water) chemical detergent and squeezed dry. To avoid damaging surface finish, do not use such solvents as thinner, benzine, etc. other than ethyl alcohol, or abrasives, bleaching agent and chemical dustcloth.

Some general-purpose household, kitchen and furniture cleaning products may contain strong solvents that degrade plastic components, coatings, and print. Before using any cleaning product, read the product's cautionary notes carefully and test the product first on a small area that is not highly visible.

12 TROUBLESHOOTING

12-1 TROUBLESHOOTING (WHEN NO ERROR MESSAGE IS SHOWN)

⚠ WARNING

- In order to prevent electric shock and short circuit, be sure to turn power off before performing work.
- Be careful so as not to damage wirings. Damaged wiring can cause electric shock or short circuit.
- After removing the cause of the functioning of the Circuit Protector, reinstate the Circuit Protector. Depending on the cause of the functioning, using the Circuit Protector as is without removing the cause can cause generation of heat and fire hazard.
- In the event that a problem cannot be resolved by employing the procedures listed in this Manual, be sure to request service from the office shown on this Manual or the dealer from whom the product was originally purchased. Attempts to employ procedures other than those specified in this Manual can cause electrical shock, shorting, or fire.
- In the event of a problem that is not described here, be sure to contact the office shown on this Manual or the dealer from whom the product was originally purchased. Careless attempts at repair can result in electrical shock, shorting, or fire.

PROBLEMS	CAUSE	COUNTERMEASURES
With Main SW ON, no activation.	Power is not supplied.	Securely insert the power plug into the plug socket.
	Power supply/voltage is not correct.	Make sure that power supply/voltage is correct.
	The circuit breaker on the power supply functioned due to momentary overcurrent.	After eliminating the cause of overload, have the circuit breaker restored.
The color on the monitor screen is incorrect.	Image adjustment is not appropriate.	Adjust appropriately
No sound is emitted.	Sound volume adjustment is not appropriate.	Adjust sound volume
	Board and Amplifier malfunctioning	Perform the sound test and confirm

12-2 ERROR CODE

This product displays the following messages when it detects an error.

ERROR 00
DISPLAY
CAUSE
ACTION

MAIN MEMORY ERROR
Abnormality of Memory RAM on AW PCB.
Need exchange or repair of Main PCB.

ERROR 01
DISPLAY
CAUSE
ACTION

ROM CARTRIDGE INCLUDES FATAL ERROR
ROM cartridge is not correctly set or abnormality is found in ROM cartridge
Need exchange or repair ROM cartridge.

DISPLAY
CAUSE
COUNTERMEASURES

COIN ERROR
Coin is jammed or coin switch is abnormality.
Check coin mech, coin switch, and harnesses to coin switch.

13 GAME BOARD

WARNING

- In order to prevent electric shock and short circuit hazards, be sure to turn power off before performing work.
- Be careful not to damage the wires. Damaged wires may cause electric shock or short circuit or present a fire risk.
- When replacing or repairing the game board and then returning it to the cabinet, be sure to reconnect all the connectors correctly. Improper connection may cause electric shock, short circuit or fire.
- When connecting the connector, check the orientation carefully and connect securely. The connector must be connected in the proper direction. If it is connected in the wrong direction or indiscriminately at an incline so that a load is applied, the connector or its terminal pins could break, causing a short circuit or fire.
- No connectors other than those connected on the game board when first delivered can be used by this product. Do not connect any other wires to any of the unused connections. This may lead to the generation of heat, smoke or burn outs.

CAUTION

In this product, setting changes are made during the test mode. The game board need not be operated. Use the game board, etc. as is with the same setting made at the time of shipment so as not to cause electric shock and malfunctioning.

DIMENSIONS: 10.67" W x 9.04" D x 2.52" H
WEIGHT: 3 lbs

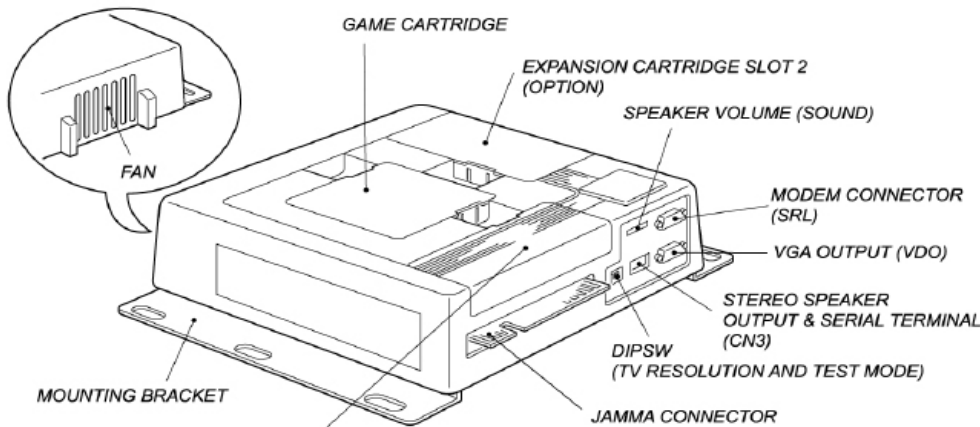

■ EXPANSION CARTRIDGE SLOT 1 (EX. I/O BOARD) CONNECTOR TABLE

CN303: 8 PIN CONNECTOR

PIN#	FUNCTION
1	+5VDC
2	+5VDC
3	GND
4	GND
5	ANALOG 0
6	ANALOG 1
7	ANALOG 2
8	ANALOG 3

CN304: 12 PIN CONNECTOR

PIN#	FUNCTION
1	+5VDC
2	+5VDC
3	GND
4	GND
5	POUT 0
6	POUT 1
7	POUT 2
8	POUT 3
9	POUT 4
10	POUT 5
11	POUT 6
12	POUT 7

CN302: 28 PIN CONNECTOR

PIN#	FUNCTION	PIN#	FUNCTION
1	+5VDC	2	+5VDC
3	GND	4	GND
5	3P GUN	6	4P GUN
7	3PUP/PULX1	8	4PUP/PULX1
9	3PDO/PULX2	10	4PDO/PULX2
11	3PLE/PULY1	12	4PLE/PULY1
13	3PRI/PULY2	14	4PRI/PULY2
15	3P COIN	16	4P COIN
17	3P START	18	4P START
19	3PPU1/TRIG	20	4PPU1/TRIG
21	3P PUSH2	22	4P PUSH2
23	3P PUSH3	24	4P PUSH3
25	3P PUSH4	26	4P PUSH4
27	3P PUSH5	28	4P PUSH5

■ JAMMA CONNECTOR TABLE

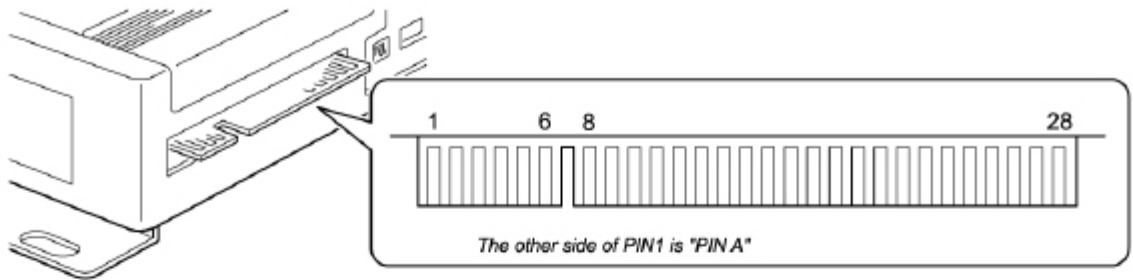

JAMMA EDGE CONNECTOR (56 PINS)

No.	FUNCTION	I/O	No.	FUNCTION	I/O
1	GND	-	A	GND	-
2	GND	-	B	GND	-
3	+5V	IN	C	+5V	IN
4	+5V	IN	D	+5V	IN
5	N.C.	-	E	N.C.	-
6	+12V	IN	F	+12V	IN
7	N.C.	-	H	N.C.	-
8	1P COIN COUNTER	OUT	J	2P COIN COUNTER	OUT
9	1P COIN LOCKOUT	OUT	K	2P COIN LOCKOUT	OUT
10	MONO SPEAKER (+)	OUT	L	MONO SPEAKER (-)	OUT
11	AUDIO OUT	OUT	M	AUDIO GND	-
12	VIDEO RED	OUT	N	VIDEO GREEN	OUT
13	VIDEO BLUE	OUT	P	VIDEO SYNC	OUT
14	VIDEO GND	-	R	SERVICE SW	IN
15	TEST SW	IN	S	TILT SW	IN
16	1P COIN	IN	T	2P COIN	IN
17	START / OVERLOOK	IN	U	NOT USED	IN
18	NOT USED	IN	V	NOT USED	IN
19	NOT USED	IN	W	NOT USED	IN
20	MOVE TO LEFT	IN	X	NOT USED	IN
21	MOVE TO RIGHT	IN	Y	NOT USED	IN
22	ROTATE LEFT	IN	Z	NOT USED	IN
23	ROTATE RIGHT	IN	a	NOT USED	IN
24	NOT USED	IN	b	NOT USED	IN
25	NOT USED	IN	c	NOT USED	IN
26	NOT USED	IN	d	NOT USED	IN
27	GND	-	e	GND	-
28	GND	-	f	GND	-

■ **SPEAKER VOLUME (SOUND)**

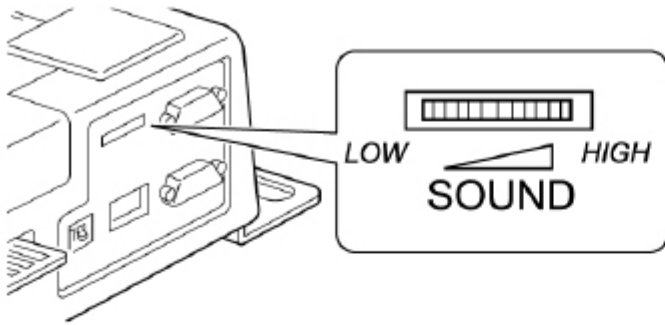

Use for adjusting game sound

■ **MODEM CONNECTOR (SRL) >>> OPTION**

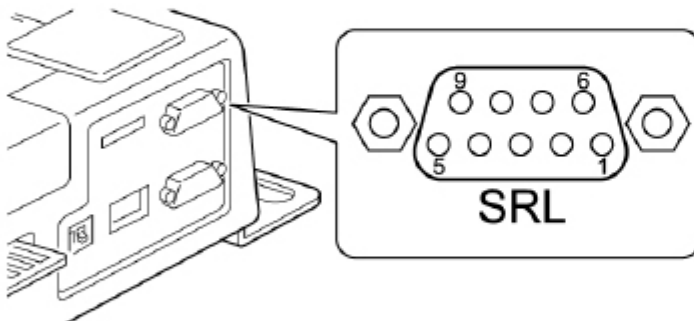

JST 9PIN SUB, CONNECTOR (MALE)

No.	FUNCTION	I/O
1	(N.C.)	-
2	RXD2	IN
3	TXD2	OUT
4	DTR	OUT
5	GND	-
6	(N.C.)	-
7	RTS	OUT
8	CTS	IN
9	(N.C.)	-

■ **DIP SWITCH (2 POSITIONS)**

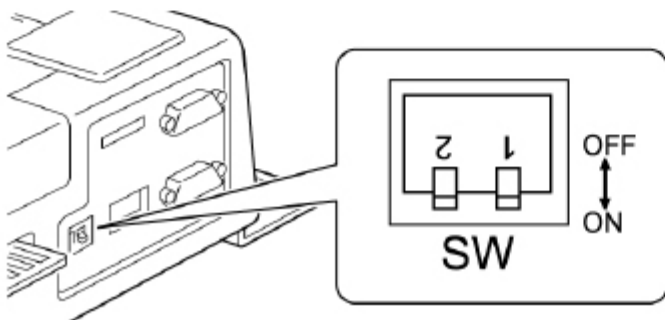

SW-1: Change Frequency of TV signal. Default is OFF = 15KHz*

*For Standard = Low resolution monitor

SW-2: Change ON position to go to SYSTEM MENU.

	ON	OFF
SW-1	31KHZ	15KHZ
SW-2	SYSTEM MENU MODE	GAME MODE

■ STEREO SPEAKER OUTPUT CONNECTOR (OPTION)

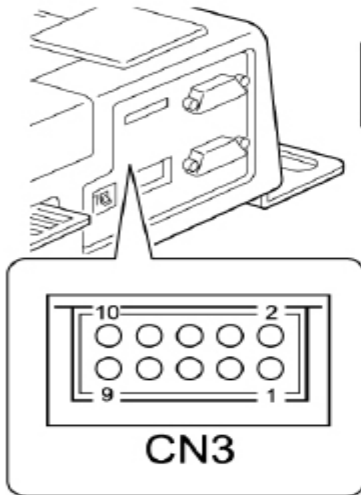

NOTE:
Can not use JAMMA speaker output & STEREO speaker output at same time.

STEREO SPEAKER OUTPUT & EXTENSION SERIAL CONNECTOR, PIN LAYOUT (JST, 10 PIN PHD CONNECTOR)

No.	FUNCTION	I/O	No.	FUNCTION	I/O
1	STEREO SPEAKER L (+)	OUT	2	TXD	OUT
3	STEREO SPEAKER L (-)	OUT	4	RXD	IN
5	STEREO SPEAKER R (+)	OUT	6	GND	-
7	STEREO SPEAKER R (-)	OUT	8	+5V	OUT
9	N.C.	-	10	N.C.	-

■ VGA (31KHz) TV SIGNAL OUTPUT CONNECTOR (VDO) >>>OPTION

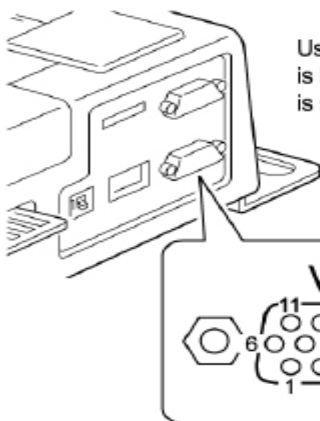

Use this connector when TV Monitor is High Resolution. Make sure DIPSW #1 is set to ON position.

VGA OUTPUT CONNECTOR, PIN LAYOUT (JST, 15 PIN D-SUB CONNECTOR, 3 SEQUENCE, FEMALE)

No.	FUNCTION	I/O
1	R	OUT
2	G	OUT
3	B	OUT
4	N.C.	-
5	GND	-
6	R-GND	-
7	G-GND	-
8	B-GND	-
9	+5V	OUT
10	GND	-
11	N.C.	-
12	N.C.	-
13	COMP SYNC	OUT
14	N.C.	-
15	N.C.	-

■ GAME CARTRIDGE

HOW TO MOUNT GAME CARTRIDGE

Check position of connector for both game cartridge and slot in MAIN PCB. Then insert Game Cartridge. Make sure that Game Cartridge is locked by hooks.

HOW TO REMOVE GAME CARTRIDGE

Pinch both Hooks on game cartridge, then pull game cartridge out. When you exchange Game Cartridge to another Game Cartridge, all backup data (bookkeeping data) will be cleared. Then all settings will go back to default settings.

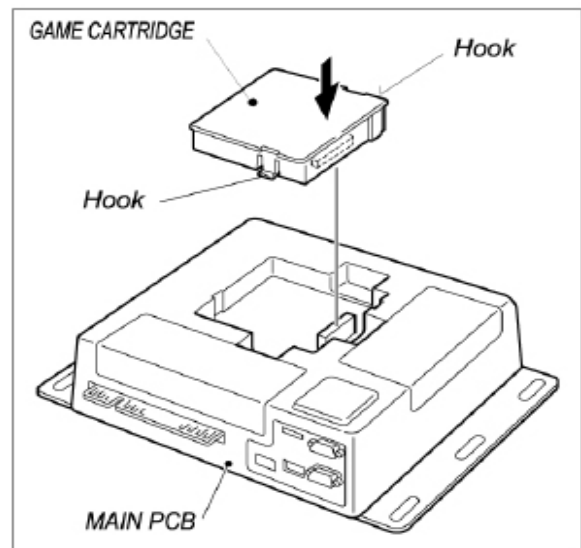

14 CABINET PARTS DESCRIPTION

HARNESS FOR MAIN A/W
Part#: 99-60-690



Main PCB, AW
Part#: 99-10-011

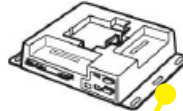

EX I/O Cartridge
Part#: 99-20-005



ASSY ROM
CTRG SBFC
Part#: 610-0752P
,+ 557-30-200

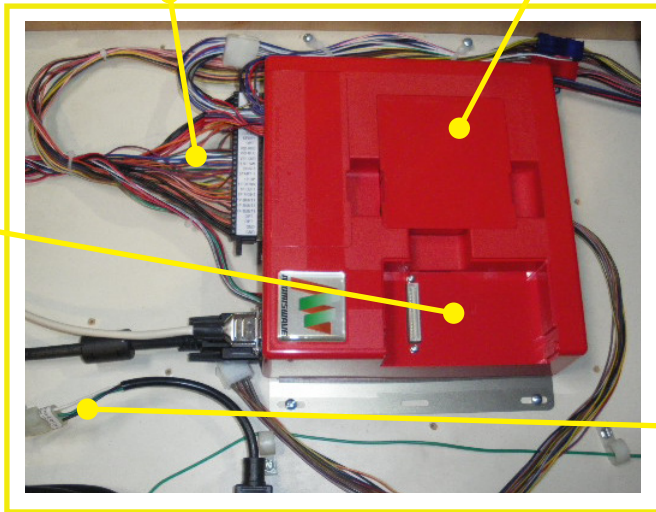

HARNESS FOR IT
PWR SPLY
Part#: 557-60-100



INSIDE VIEW OF COIN DOOR, AW25"UR & 29"UR

Coin Door Mid Width 40-3000
Part#: 99-70-103

Security Bar KIT, MID
(Option)
Part#: 99-70-278

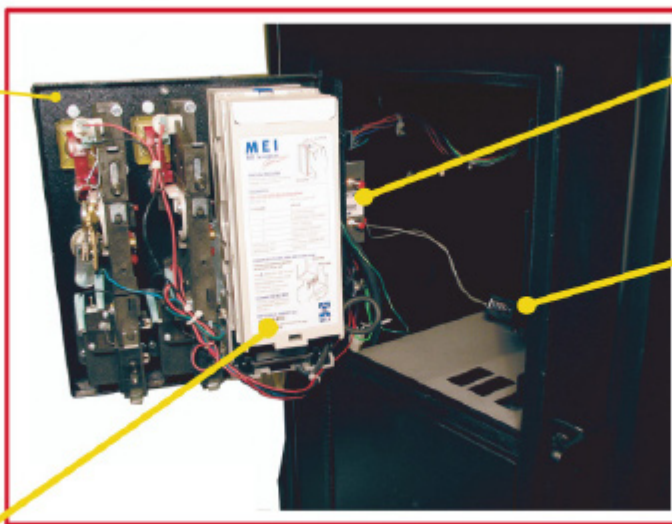

Test & Service
Switch Bracket

Meter 12 Volt Coin Door
Part#: 99-70-184

Mars DBA
AE2451 (OPTION)

15 WIRE COLOR CODE TABLE

⚠ WARNING

The DC power wire color for this product is different from previous SEGA titles. Working from the previous wire colors will create a high risk of fire.

The color codes for the wires used in the diagrams in the following chapter are as follows.

- A PINK
- B SKY BLUE
- C BROWN
- D PURPLE
- E LIGHT GREEN

Wires other than those of any of the above 5 single colors will be displayed by 2 alphanumeric characters.

- 1 RED
- 2 BLUE
- 3 YELLOW
- 4 GREEN
- 5 WHITE
- 7 ORANGE
- 8 BLACK
- 9 GRAY

If the right-hand side numeral of the code is 0, then the wire will be of a single color shown by the left-hand side numeral (see the above).

Note 1: If the right-hand side numeral is not 0, that particular wire has a spiral color code. The left-hand side character shows the base color and the right-hand side one, the spiral color.

<Example> 51.....WHITE/RED

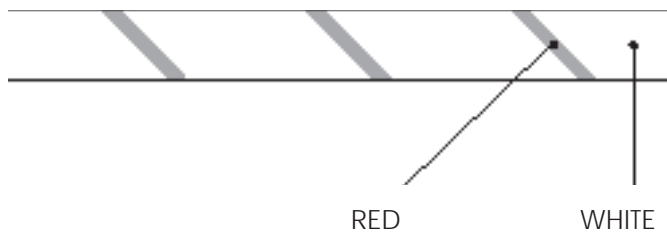

Note 2: The character following the wire color code indicates the size of the wire.

- U: AWG16
- K: AWG18
- L: AWG20
- None: AWG22

16 WIRING DIAGRAM

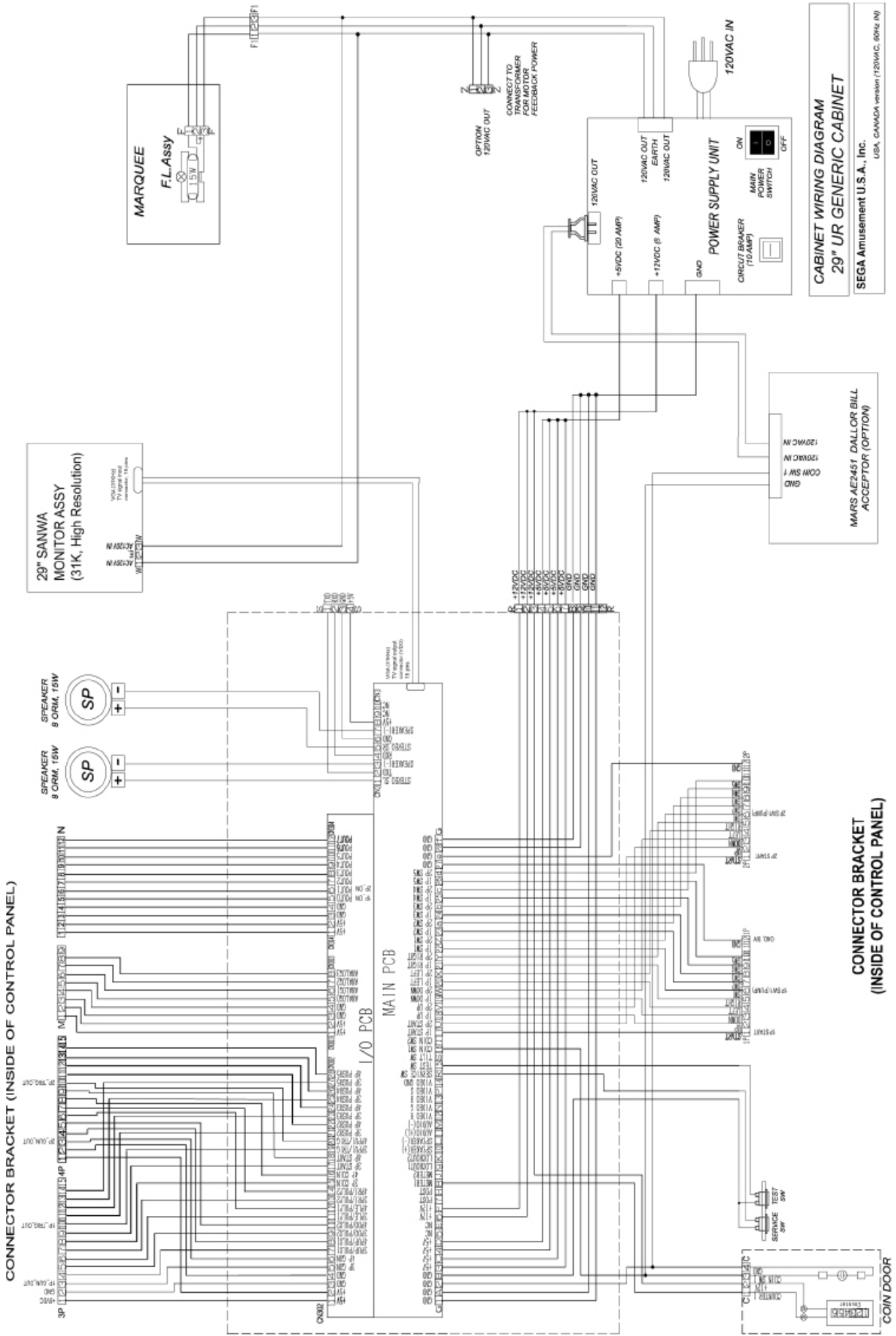

16 WIRE COLOR CODE TABLE

17 LICENSE MARK

The Font to be used in the game.

The typefaces included herein are solely developed by DynaComware.

18 PRINTER KIT (OPTION)

SEGA BASS FISHING CHALLENGE, PRINTER KIT

KIT Part#: 557-00-069

PRINTER WITH PAPER HOLDER
Part#: 99-00-919

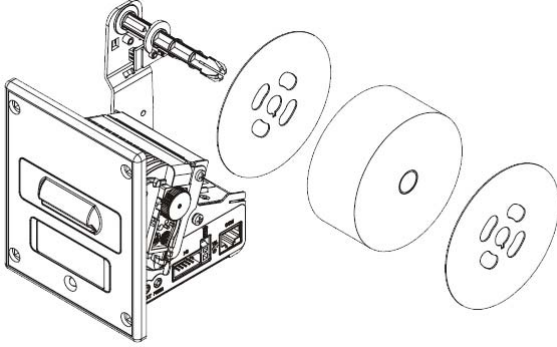

PRINTER SERIAL CABLE
Part#: 99-00-922



19 PRINTER KIT INSTALLATION (EXAMPLE)

1) Take 3 screws off to remove DBA door from cabinet.

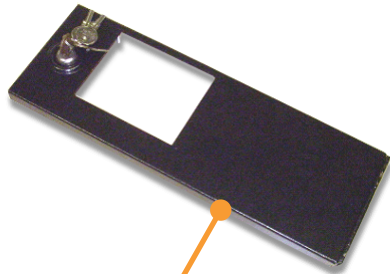

DBA DOOR



2) Insert paper holder to printer as below angle.

For Paper Roll order, ask SEGA Amusement USA for details

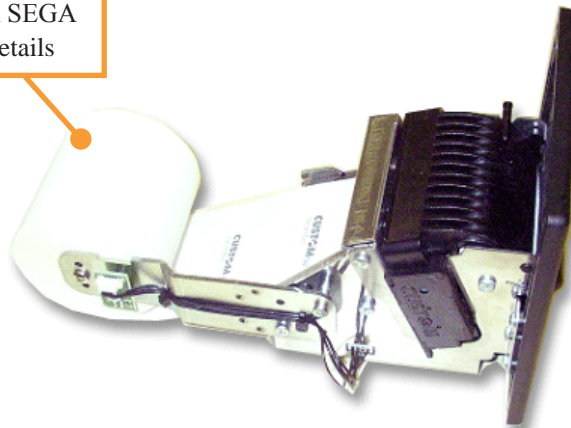

3) Place PRINTER PANEL that will tight together with mounting PRINTER. Make sure do not loose it.

PRINTER PANEL



4) Insert PRINTER from front side of DBA Door that removed from cabinet.

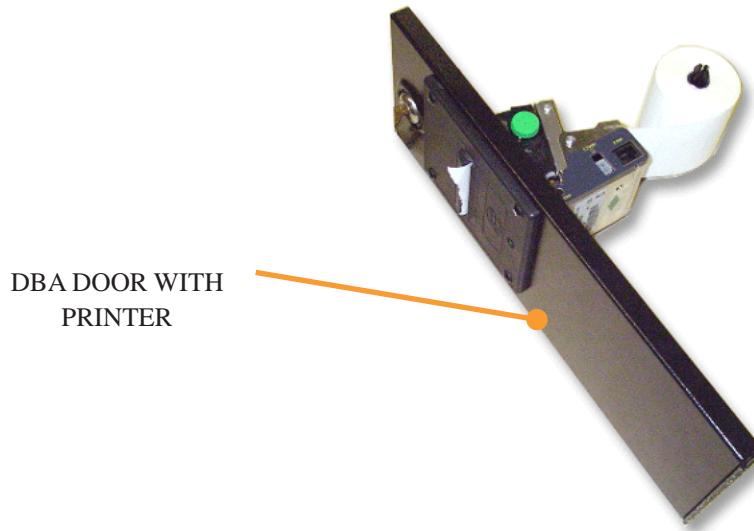

5) Move DBA harness near the Coin door inside.
(DBA will re-mount to Upper Coin Door after exchange it. Refer next page.)

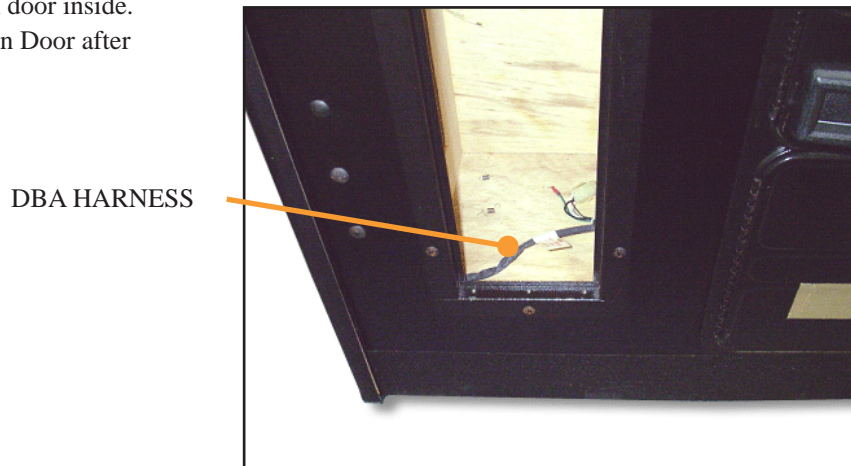

6) Remount DBA Door with PRINTER with using original 3 screws.

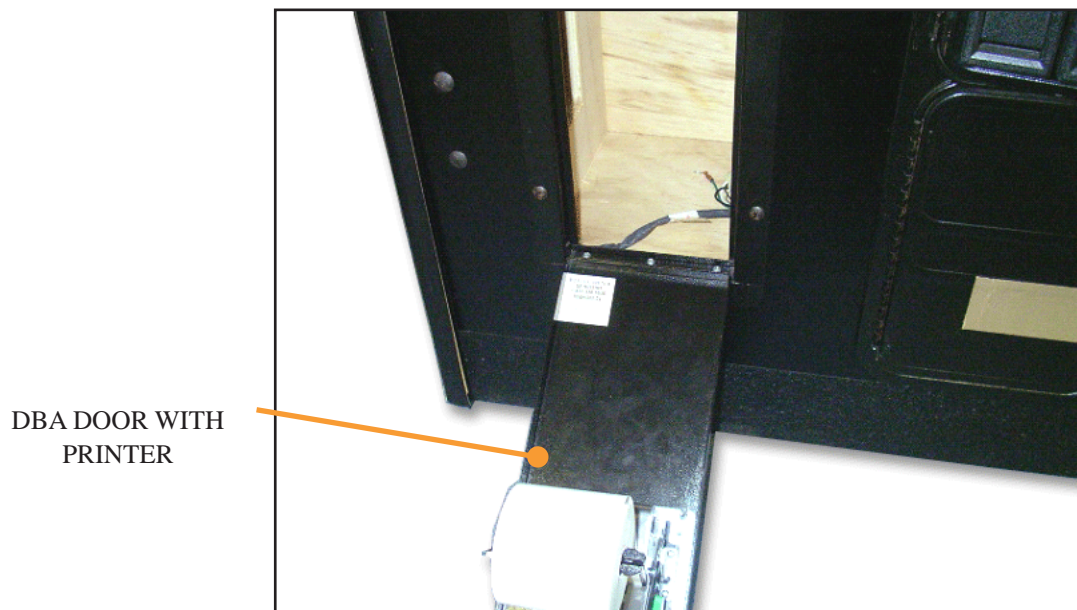

7) Connect **PRINTER POWER CABLE** and **PRINTER CABLE** that from inside of cabinet..

PRINTER POWER CABLE

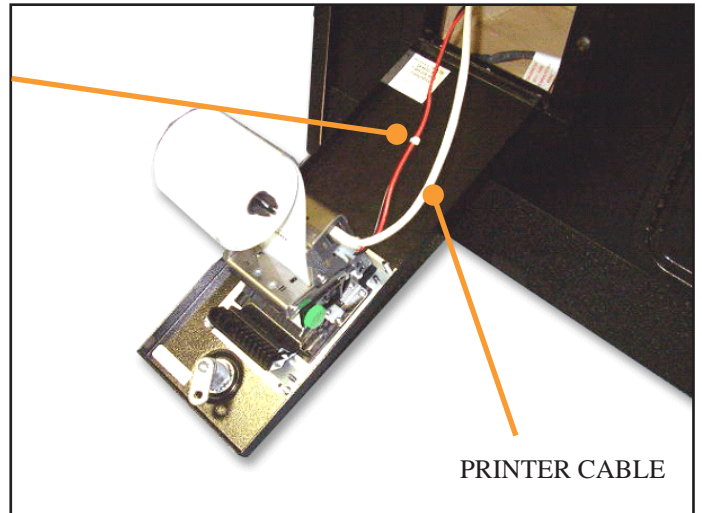

8) Push in both connectors when open / close the door.

CAUTION:
Push in both connectors
when open / close the door.

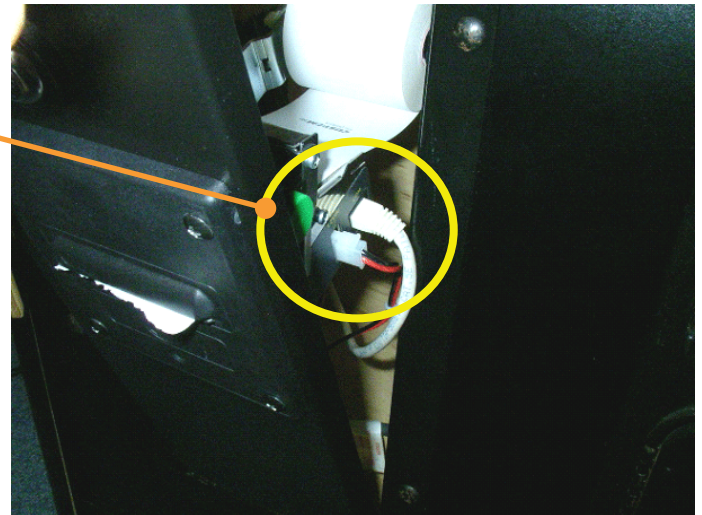

9) Connect **PRINTER CABLE**. Place **POWER SUPPLY UNIT (For Printer)** around **AW MAIN PCB**.

PRINTER CABLE
(Connect here)

TRACKBALL HARNESS

AC POWER CORD
(NOTE: **POWER SUPPLY UNIT** for printer require 120VAC Input. Connect **AC LINE CORD** to 120VAC line in cabinet.)

AW MAIN PCB

POWER SUPPLY UNIT (For Printer)

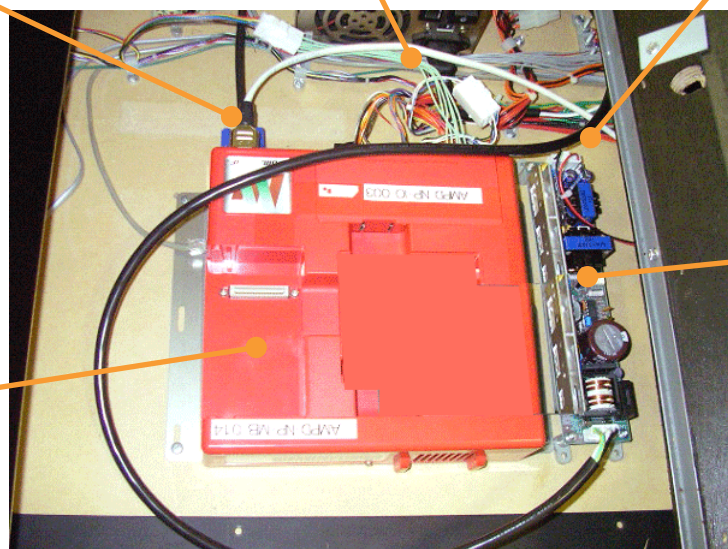

10) TRACKBALL HARNESS connect to EX I/O connector. Then connect to connector that come from original trackball.

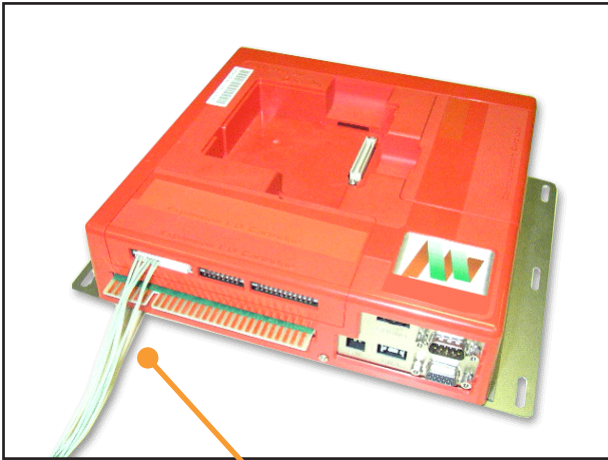

TRACKBALL HARNESS

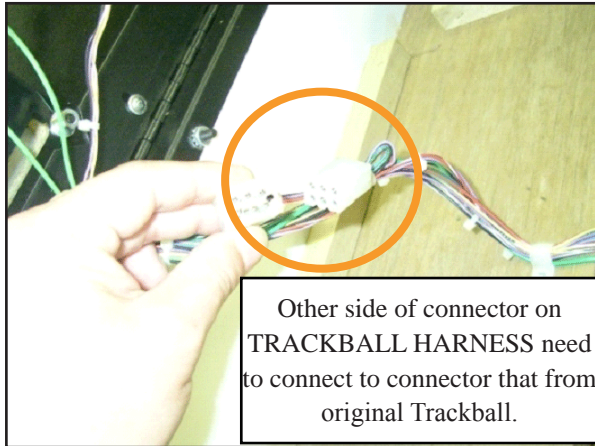

Other side of connector on TRACKBALL HARNESS need to connect to connector that from original Trackball.

11) Exchange Upper Coin Door as below type (DBA ready type) that able to mount DBA unit.

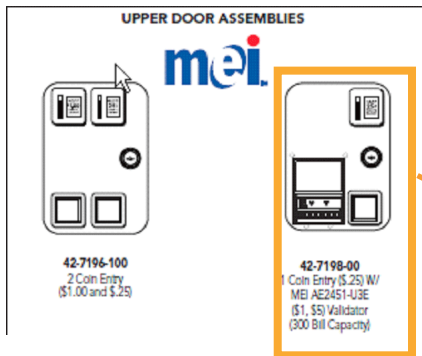

DO NOT USE THIS DEVICE for SEGA Bass Fishing Challenge.



NOTES

9 PRINTER KIT (OPTION)

NOTES

WARRANTIES

GAME WARRANTY POLICY

Your new SEGA PRODUCT is covered for a period of ninety (90) days from the date of the shipment. This certifies that all Printed Circuit boards, power supplies and monitors are to be free of defects in workmanship or materials under normal operating conditions.

This also certifies that all Interactive Control Assemblies are to be free from defects in workmanship and materials under normal operating conditions. No other product in this machine is hereby covered. Sellers sole liability in the event a warranted part described above fails shall be, at its option, to replace or repair the defective part during the warranty period. For warranty claims, contact your SEGA Distributor. Should the seller determine, by inspection that the problem was caused by accident, misuse, neglect, alteration, improper repair, installation or testing, the warranty offered will be null and void.

Under no circumstances is the seller responsible for any loss of profits, loss of use, or other damages. This shall be the exclusive written Warranty of the original purchaser expressed in lieu of all other warranties expressed or implied. Under no circumstances shall it extend beyond the period of time listed above.

PARTS WARRANTY POLICY

Sega Amusements USA, Inc. warrants all parts to be free from defective materials and workmanship for a period of thirty (30) days from Sega Amusements USA, Inc. invoice date unless otherwise specified in writing by Sega Amusements USA, Inc.

This limited warranty is invalid for any part that upon examination, is deemed to have been subject to misuse, improper repair or installation, neglect or violation of specification or other instructions published by Sega Amusements USA, Inc. There are no additional warranties described above.

The limited warranties described above shall be in lieu of any other warranty, express or implied, including but not limited to any implied warranty of merchantability or fitness for a particular purpose.